

FenceGuards™, Rail Padding & Fence Slats

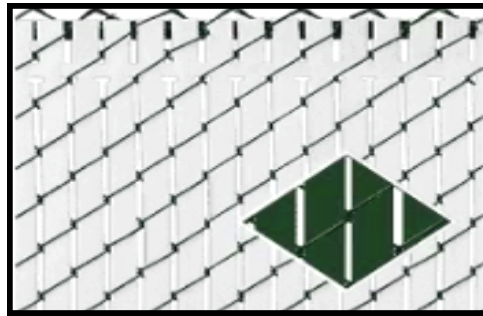
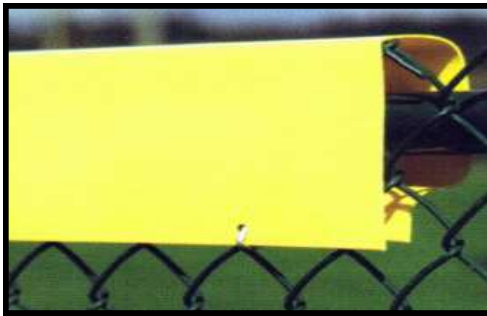
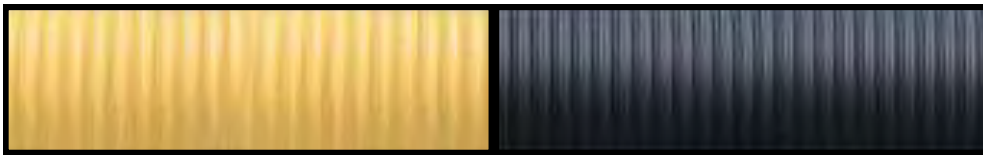

- Fence Guards 2
- Econo Guards (Corrugated / Poly-Cap) 3
- Fence Crowns 3
- Safety Top Caps 4
- Foam Guards..... 5
- Rail & Post Padding 6-8
- Privacy / Chain Link Fence Slats 9-13

YOUR “ONE-STOP” SOURCE FOR AMERICA’S BASEBALL, SOFTBALL & SPORTS SURFACES & SUPPLIES!

PRICES SUBJECT TO CHANGE & AVAILABILITY PLUS SHIPPING | VOLUME DISCOUNTS AVAILABLE | COOPERATIVE PURCHASING CONTRACT PRICING FOR 50 STATES

BEAM CLAY®

WHOLESALE PRICE LIST EFFECTIVE: JULY 1, 2021

Fence Guard Protective Covers for the Top Rail of Chain Link Fences

FENCE GUARDS™ Heavy-duty, UV-resistant MDPE polyethylene. Twelve 7-foot sections (84") per carton with pre-drilled holes every 2' for securing to fence; and includes ties for securing to fence; full cartons only.

PRICE

PREMIUM FENCE GUARDS™

3" W x 4-1/2" H x 7' Long x .1" wall.

SAFETY YELLOW—#01166-YEL7, Dark Green—#01166-GRN7, Red—#01166-RED7, or Blue—#01166-BLU7.
 5-Year Limited Manufacturer's Warranty.

\$195/Box

STANDARD FENCE GUARDS™

2-5/8" W x 4" H x 7' Long x .07" wall.

SAFETY YELLOW—#01923-YEL7, Dark Green—#01923-GRN7, Red—#01923-RED7, White—#01923-WHT7, Blue—#01923-BLU7, or Orange—#01923-ORA7.
 3-Year Limited Manufacturer's Warranty.

\$145/Box

LITE FENCE GUARDS™

2-5/8" W x 4" H x 7' Long x .05" wall.

SAFETY YELLOW—#03022-YEL7, Dark Green—#03022-GRN7, or Red—#03022-RED7.
 1-Year Limited Manufacturer's Warranty.

\$120/Box

Extra Packs of 100 - 8" Black UV-Resistant Ties **#PT-8BK**

\$10.00/Pk



**3 Grades
 &
 6 Colors!**

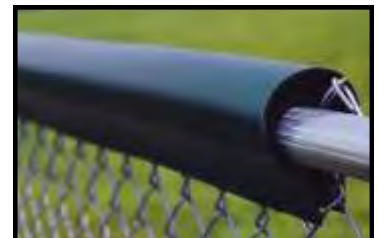

YOUR "ONE-STOP" SOURCE FOR AMERICA'S BASEBALL, SOFTBALL & SPORTS SURFACES & SUPPLIES!

PRICES SUBJECT TO CHANGE & AVAILABILITY PLUS SHIPPING | VOLUME DISCOUNTS AVAILABLE | COOPERATIVE PURCHASING CONTRACT PRICING FOR 50 STATES

PARTAC PEAT CORPORATION
 ONE KELSEY PARK, GREAT MEADOWS, NEW JERSEY 07838

800-247-BEAM (2326) • (908) 637-4191 • FAX (908) 637-8421
 www.beamclay.com • sales@beamclay.com
 Bid Term - 5/9/18 - 5/8/20; Extended to 5/8/21; Extended to 5/8/22

BEAM CLAY®

WHOLESALE PRICE LIST EFFECTIVE: JULY 1, 2021

Econo Guard (Poly-Cap) & Fence Crown Protective Covers for the Top Rail of Chain Link Fences

ECONO GUARDS™ CORRUGATED FENCE CAP *Bright Safety Yellow, Green, Black, Orange & Red*

The Original (Hi-Rib) Poly Cap. Pre-slit weather-treated and UV protected corrugated 100% virgin high density polyethylene in rolls, 4" ID x 4-1/2" OD x 1/16" (.0625") wall thickness with rounded corner profile for added strength. Manufactured with the thickest wall creating unequalled durability and UV protection. Fasten with matching 19" yellow plastic ties (not included) at beginning and end and every 3-5'. 3-Year Limited Manufacturer's Warranty. Ships by common carrier in cardboard box.

250' Roll, 85 lbs. Orange #06069, Black #04449, Yellow #01162, Green #02372, Red #02141

\$235

100' Roll, 35 lbs. Orange #06070, Black #04450, Yellow #01160, Green #02373, Red #02142

\$115

18" UV-resistant, reusable Plastic Ties per 100—Yellow #01649 or Black #04451,

\$35



INSTALLATION TOOLS - Cut installation time by up to 75%. Poly cap can be difficult to spread and hard on your hands and knuckles. Neither of these tools are required, but either one of these tools would make installation easier.

Zipper Installation Tool #05072

\$65

FENCE CROWN®

Athletic Gold, Safety Yellow or Black. 4" ID x 4 1/2" OD. Fasten with yellow or black 19" plastic ties (not included) at beginning and end and every 3-5'. Ships by common carrier.

250' Roll—250' to 1,500' #FC250Y or #FC250B
 —more than 1,500' #FC250Y+ or #FC250B+

\$175
\$165

100' Roll—100' to 1,500' #FC100Y or #FC100B
 —more than 1,500' #FC100Y+ or #FC100B+

\$100
\$95

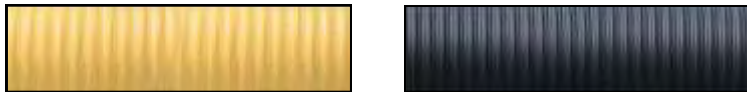

18" Yellow or Black UV-resistant, reusable **Plastic Ties** per 100 Black #04451, Yellow #01649

Zipper Installation Tool #05072

\$35

\$65

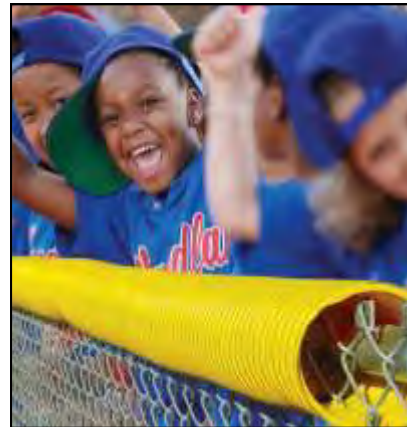

OPTIONAL ACCESSORIES

Easy to secure with 19" tie wraps Attaching tool makes installation on fence-tops easy

YOUR "ONE-STOP" SOURCE FOR AMERICA'S BASEBALL, SOFTBALL & SPORTS SURFACES & SUPPLIES!

PRICES SUBJECT TO CHANGE & AVAILABILITY PLUS SHIPPING | VOLUME DISCOUNTS AVAILABLE | COOPERATIVE PURCHASING CONTRACT PRICING FOR 50 STATES

BEAM CLAY®

WHOLESALE PRICE LIST EFFECTIVE: JULY 1, 2021

Premium & Lite Safety Top Caps Protective Covers for the Top Rail of Chain Link Fences

PREMIUM SAFETY TOP CAPS™

Heavy-duty, rectangular, protective cover for top rails of chain link fencing. .07" HDPE Plastic with UV stabilizers. Secures with included hog rings through pre-drilled holes. 40 ft. per bag (includes 5—8' sections, 3 hole punched plus 15 hot rings), 20 lbs. **Stock color: Safety Yellow.** 10 standard colors (Dark Green, Royal Blue, Sky Blue, Red, Redwood, Brown, Beige, Grey, Black, White): 1600' minimum (40 bag) order, 4-6 weeks lead time, no returns.

PREMIUM SAFETY YELLOW—stock color.

40'/BAG 1—39 bags

#PSC-Y-L1

\$105

40'/BAG 40—119 bags

#PSC-Y-L2

\$99

40'/BAG 120+ bags

#PSC-Y-L3

\$91

PREMIUM BLACK—if in stock.

40'/BAG 1—39 bags

#PSC-B-L1

\$125

10 STANDARD COLORS—Dark Green, Royal Blue, Light Blue, Red, Redwood, Brown, Beige, Grey, Black, or White. 1600' minimum unless in stock (40 bag) order, 4-6 weeks lead time, no returns.

#PSC-SC-L3

\$125

CUSTOM COLORS

1600' minimum (40 bag) order, 6-8 weeks lead time, no returns.

#PSC-CC-L3

\$155

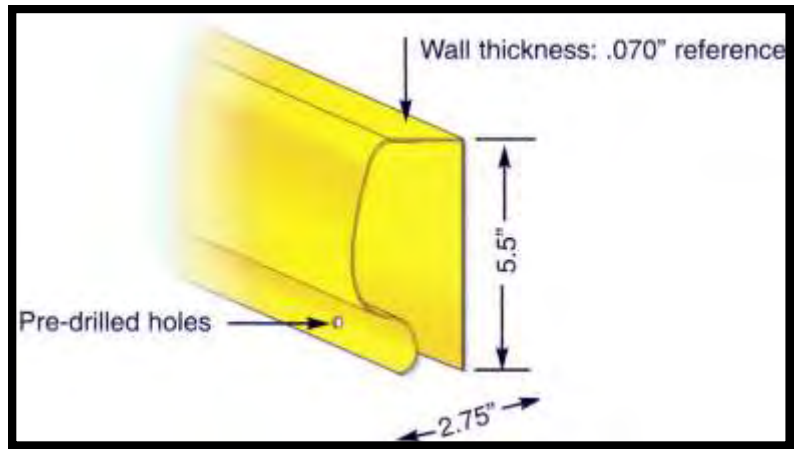
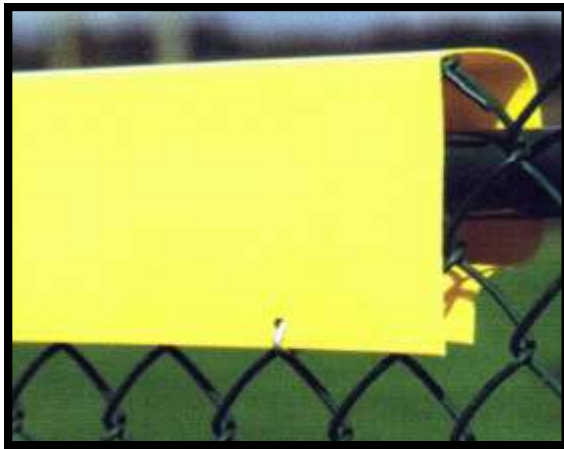

SAFETY TOP CAP—LITE™

- A Lighter, More Affordable Option for an open spec, 2.25"W x 4"H x 8'Long
- 10 - 8' pieces at 80' per bag / 4-hole punched with 40 Black Zip Ties - Included
- 40 bags per crate (3,200' coverage per crate)

SAFETY YELLOW (stock color)

80'/BAG 1—39 bags

#STCL-Y-L1

\$103

80'/BAG 40—119 bags

#STCL-Y-L2

\$97

80'/BAG 120+ bags

#STCL-Y-L3

\$89

BLACK (if in stock)

80'/BAG 1—39 bags

#STCL-B-L1

\$120

10 STANDARD COLORS—Dark Green, Royal Blue, Sky Blue, Red, Redwood, Brown, Beige, Grey, Black, or White. 3,200' minimum (40 bag) order (unless in stock), 4-6 weeks lead time, no returns.

#STCLSC-L3

\$120

CUSTOM COLORS

3,200' minimum (40 bag) order, 6-8 weeks lead time, no returns.

#STCL-CC-L3

\$145



YOUR "ONE-STOP" SOURCE FOR AMERICA'S BASEBALL, SOFTBALL & SPORTS SURFACES & SUPPLIES!

PRICES SUBJECT TO CHANGE & AVAILABILITY PLUS SHIPPING | VOLUME DISCOUNTS AVAILABLE | COOPERATIVE PURCHASING CONTRACT PRICING FOR 50 STATES

BEAM CLAY®

WHOLESALE PRICE LIST
 EFFECTIVE: JULY 1, 2021

Foam Guards™ & Safe Foam™ Rail Padding

FOAM GUARDS™ & SAFE FOAM™ RAIL PADDING

3/4" Thick x 8' Long Closed-Cell, Polyethylene Tubular Padding fits completely around any round pipe or rail 2" or less in diameter. Pre-slit for easy installation. Can be easily cut and mitred in the field for custom fit. No grommets—attach with plastic ties around outside of tube. Use with 3 colored plastic ties per straight length. Durable tough skin coating to prevent wear and UV-breakdown. 5-year manufacturer's warranty. Up to 15 lengths per UPS O.S. Box.

PREMIUM - With Tough Skin Coating. Available in Yellow, Green, Red, Royal Blue, Sky Blue, Black, Grey, Purple, 3-5/8" O.D. x 2-1/8" I.D. x 3/4" wall thickness. Yellow in stock. Other colors are custom ordered.

1-19 (8') Lengths	#P-SF1-19	\$41/Length
20 or More (8') Lengths	#P-SF20+	\$37/Length

STANDARD - Without Tough Skin Coating. Yellow only. 3-year manufacturer's warranty.

2" Wall Thickness 1-19 (8') Lengths	#SFG2-1-19	\$37/Length
2" Wall Thickness 20 or More (8') Lengths	#SFG2-20+	\$32/Length

19" PLASTIC TIES

Yellow **#19TIESY** or Black **#19TIESB**.

Packs of 100

\$25/Pack

24" PLASTIC TIES - Natural/Off White for 2" Thick Pads **#24TIESN**

Packs of 100

\$30/Pack

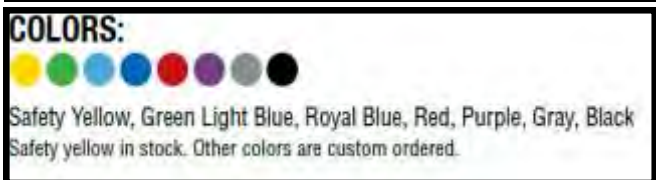
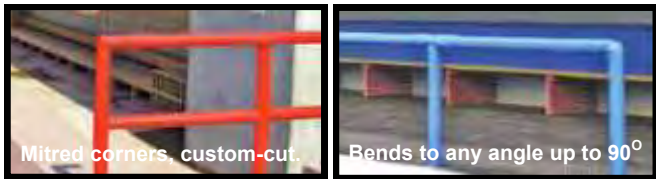
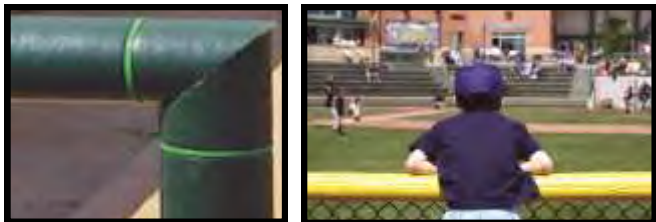

YOUR "ONE-STOP" SOURCE FOR AMERICA'S BASEBALL, SOFTBALL & SPORTS SURFACES & SUPPLIES!

PRICES SUBJECT TO CHANGE & AVAILABILITY PLUS SHIPPING | VOLUME DISCOUNTS AVAILABLE | COOPERATIVE PURCHASING CONTRACT PRICING FOR 50 STATES

BEAM CLAY®

WHOLESALE PRICE LIST EFFECTIVE: JULY 1, 2021

Rail & Post Padding

CHAIN LINK FENCE TOP RAIL AND POST PADS

Designed to cover the dangerous vertical and horizontal posts and allow for view through the fence. Made of 3" high-density open cell foam fully encased in 18 oz. UV-resistant vinyl. Attach with nylon ties (not included) through grommets every 6".

Chain Link Top Rail Pad, 3" Foam, 9" face, 6" top, 1-1/2" flaps, grommets every 6"	#CLTR	\$36/LF
Chain Link Post Pad—Horizontal, 3" Foam, 6" wide w/1-1/2" flaps, grommets every 6"	#CLPH	\$26/LF
Chain Link Post Pad—Vertical, 3" Foam, 6" wide w/1-1/2" flaps, grommets every 6"	#CLPV	\$26/LF

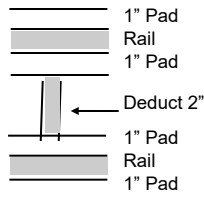
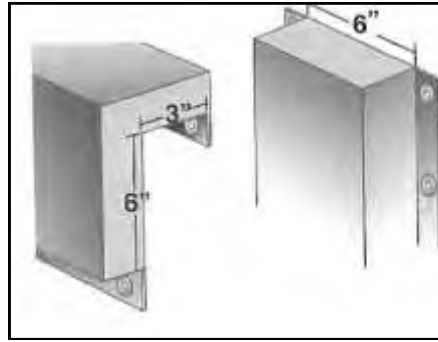

RAIL GUARDS™ DUGOUT RAIL PADDING

1" thick semi-rigid closed-cell polyethylene foam encased in 18 oz. vinyl with grommets every 6" for attachment to up to 2-1/2" diameter railing. Specify color Maple Green, Kelly Green, Royal Blue, Navy Blue, Sky Blue, Red, Orange, Yellow, White, Black, Grey, Tan, Purple, and Maroon.

1" #RG1 \$24.95/LF

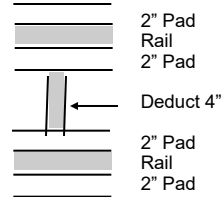

RAIL GUARDS™ RAIL & FENCE-TOP PADDING

2" thick semi-rigid closed-cell polyethylene foam fully encased in 18 oz. vinyl with grommets every 6" for attachment to up to 2-1/2" diameter railing. Specify color Maple Green, Kelly Green, Royal Blue, Navy Blue, Sky Blue, Red, Orange, Yellow, White, Black, Grey, Tan, Purple, and Maroon.

2" #RG2 \$27.95/LF

YOUR "ONE-STOP" SOURCE FOR AMERICA'S BASEBALL, SOFTBALL & SPORTS SURFACES & SUPPLIES!

PRICES SUBJECT TO CHANGE & AVAILABILITY PLUS SHIPPING | VOLUME DISCOUNTS AVAILABLE | COOPERATIVE PURCHASING CONTRACT PRICING FOR 50 STATES

BEAM CLAY®

WHOLESALE PRICE LIST EFFECTIVE: JULY 1, 2021

Aer-Cushion Rail Padding

AER-CUSHION FLAT RAIL PADDING			EACH
<i>(OPEN-CELL FOAM ENCASED IN 18 OZ. VINYL—18 COLORS)</i>			
Grommets spaced every 8" O.C. along two grommet flaps.			
16FRP	1" THICK FOAM X 6" WIDE (TO FIT UP TO 1" DIA. POLE)	LF	\$16
17FRP	1" THICK POLYFOAM X 7" WIDE (TO FIT UP TO 1.5" DIA. POLE)	LF	\$16.25
18FRP	1" THICK POLYFOAM X 8" WIDE (TO FIT UP TO 2" DIA. POLE)	LF	\$16.35
19FRP	1" THICK POLYFOAM X 9" WIDE (TO FIT UP TO 3" DIA. POLE)	LF	\$16.35
110FRP	1" THICK POLYFOAM X 10" WIDE (TO FIT UP TO 3.5" DIA. POLE)	LF	\$16.55
26FRP	2" THICK POLYFOAM X 6" WIDE (TO FIT UP TO 1" DIA. POLE)	LF	\$16.35
27FRP	2" THICK POLYFOAM X 7" WIDE (TO FIT UP TO 1.5" DIA. POLE)	LF	\$16.45
28FRP	2" THICK POLYFOAM X 8" WIDE (TO FIT UP TO 2" DIA. POLE)	LF	\$15.65
29FRP	2" THICK POLYFOAM X 9" WIDE (TO FIT UP TO 3" DIA. POLE)	LF	\$16.75
210FRP	2" THICK POLYFOAM X 10" WIDE (TO FIT UP TO 3.5" DIA. POLE)	LF	\$17.35

CHROMA-BOND IMPRINTING

Chroma-Bond Imprinting, 1 Color Logo Only

1COL25SF	Up to 25SF	\$550/EA
1COL2650SF	26SF—50SF	\$725/EA
1COL51100SF	51SF-100SF	\$995/EA

Chroma-Bond Imprinting, 2 Color Logo Only

2COL25SF	Up to 25SF	\$675/EA
2COL2650SF	26SF—50SF	\$850/EA
2COL51100SF	51SF-100SF	\$1,150/EA

Chroma-Bond Imprinting, 3 Color Logo Only

3COL25SF	Up to 25SF	\$760/EA
3COL2650SF	26SF—50SF	\$925/EA
3COL51100SF	51SF-100SF	\$1,215/EA

Chroma-Bond Imprinting		Chroma-Bond Imprinting	
1 Color	Letters or Numbers	2 Color	
1COL24	Up to 24" Tall	2COL24	\$76/EA
1COL36	36" Tall	2COL36	\$88/EA
1COL48	48" Tall	2COL48	\$104/EA
1COL60	60" Tall	2COL60	\$118/EA
1COL72	72" Tall	2COL72	\$139/EA
1COL84	84" Tall	2COL84	\$151/EA
1COL96	96" Tall	2COL96	\$171/EA
1COL108	108" Tall	2COL108	\$198/EA
1COL120	120" Tall	2COL120	\$226/EA



U-SHAPED WOOD BACKED RAIL PADS			
<i>(18 OZ. VINYL—18 COLORS)</i>			
WBUSHAPEX	U-Shaped Pad	LF	\$32
WBFLAT	Flat Pad	LF	\$21.50
WBUSHAPEHARDWARE	Hardware for U-Shaped Pad	SET	\$9
WBFLATHARDWARE	Hardware for Flat Pad	SET	\$1.85
VELCROWRAP	Velcro Wrap	LF	\$7



YOUR "ONE-STOP" SOURCE FOR AMERICA'S BASEBALL, SOFTBALL & SPORTS SURFACES & SUPPLIES!

PRICES SUBJECT TO CHANGE & AVAILABILITY PLUS SHIPPING | VOLUME DISCOUNTS AVAILABLE | COOPERATIVE PURCHASING CONTRACT PRICING FOR 50 STATES

Do-It-Yourself Top Rail/Dugout Padding

DIY Padding: Tubular Foam with core cut out to fit rail OD. 85 lb. ILD foam cut in lengths of 6' covered with 18 oz. outdoor vinyl cut to custom lengths with a reinforced hem along length, double stitched with grommets every 6". Cut excess foam off and push extra vinyl into core for finished end and to protect foam from sunlight. Secure with ties or lacing twine.

Material: Foam wrapped in 18 oz Vinyl Colors: Green, Royal Blue, Yellow, White, Red, Black, Grey, and more.

BF4RP	4" Foam diameter (TO FIT UP TO 1" -1-5/8" DIA. POLE)	LF	\$15
BF45RP	4.5" Foam diameter (TO FIT UP TO 2" -2-1/2" DIA. POLE)	LF	\$17.50
BF5RP	5" Foam diameter (TO FIT UP TO 2-1/2" -3" DIA. POLE)	LF	\$20
BF55RP	5.5" Foam diameter (TO FIT UP TO 3" -3-1/2" DIA. POLE)	LF	\$23.50
LT300	#60 Lacing Twine 300' Spool	EA	\$25
PT-7.5BK	7-1/2" 50 LB. UV-Resistant Black Plastic Ties (Packs of 100)	PK	\$10
PT-HD8BK	8" 120 LB. Heavy-Duty UV-Resistant Black Plastic Ties (Packs of 100)	PK	\$15



YOUR "ONE-STOP" SOURCE FOR AMERICA'S BASEBALL, SOFTBALL & SPORTS SURFACES & SUPPLIES!

PRICES SUBJECT TO CHANGE & AVAILABILITY PLUS SHIPPING | VOLUME DISCOUNTS AVAILABLE | COOPERATIVE PURCHASING CONTRACT PRICING FOR 50 STATES

BEAM CLAY®

WHOLESALE PRICE LIST

Chain Link Fence Slats

PRIVACY DECORATIVE SLATS (PDS®) FOR CHAIN LINK FENCING



Made in the USA: Be aware of some non-USA made fence slats that may fade and discolor. Our PDS® slats are made of virgin High Density Polyethylene (HDPE) are made in the USA and have UV inhibitors (UV resistant color concentrates) to add color protection and guard against cracking, chalking, and fading in the sunlight.

Durability: Our PDS® slats are resistant to: severe weather conditions, salt water, sand, road dirt, most acids, alcohol, alkaline, ammonia, petroleum distillates and common environmental pollutants.



Standard Colors*

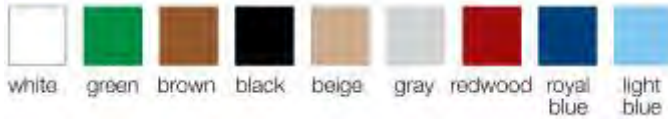

* Exact representation of slat colors in printing is difficult. Please refer to actual color samples for final matching.

* Special colors are available upon request. Minimum quantities apply.

* Made in the USA

ASTM

“Meets ASTM3000 and ASTM3000M specifications”

Materials

All except Hedgelink® are extruded from High Density Prime Polyethylene, color pigments and ultra violet (UV) inhibitors, specifically designed to retard the harmful effects of the sun and lengthen the life of the product.

Maintenance

Cleaning of most surface contaminants is quickly accomplished with plain water.

Wind Load Disclaimer

Seller/Manufacturer will not be responsible for fence damage resulting from wind load conditions due to insufficient structural support.

Limited Warranty

PDS® Fence Products carry an extensive, pro-rata warranty against breakage and material degradation under normal conditions.

WHAT SIZE PDS® FENCE SLATS WILL WORK IN YOUR CHAIN LINK FENCE?

The PDS® Fence products are available in a variety of Fence Privacy Slats (Inserts), which fit in different sizes of chain link fencing. We have Fence Slats that fit into the following diamond sizes: 1-3/4", 2", 2-1/4", 2-3/8" and 3-1/2" x 5".

Before you order Fence Slats, you must first determine the size of the “diamond” on your fence. This is done by measuring the inside dimensions diagonally in both directions. (See Photos Above)

Please note: The wire gauge (thickness), will affect the fit of our Fence Slats. Each product in this brochure includes a chart to show what size Fence Slat needs to be ordered for the various diamonds and gauge combinations available in the marketplace.

Above is a measurement of a 2" Chain Link Diamond.

YOUR “ONE-STOP” SOURCE FOR AMERICA’S BASEBALL, SOFTBALL & SPORTS SURFACES & SUPPLIES!

PRICES SUBJECT TO CHANGE & AVAILABILITY PLUS SHIPPING | VOLUME DISCOUNTS AVAILABLE | COOPERATIVE PURCHASING CONTRACT PRICING FOR 50 STATES

BEAM CLAY®

WHOLESALE PRICE LIST EFFECTIVE: JULY 1, 2021

Chain Link Fence Slats

PRIVACY DECORATIVE SLATS (PDS®) FOR CHAIN LINK FENCING

Price per bag or box — 10 linear feet per bag or box.

Bottom Lock					
Length	Weight	Item#	1-599	Item#	600-1199
3'	7 #	BL7(?)L1	\$39	BL7(?)L2	\$33
3.5'	8 #	BL8(?)L1	\$44	BL8(?)L2	\$38
4'	9 #	BL9(?)L1	\$44	BL9(?)L2	\$38
5'	12 #	BL12(?)L1	\$55	BL12(?)L2	\$47
6'	14 #	BL14(?)L1	\$66	BL14(?)L2	\$57
7'	17 #	BL17(?)L1	\$77	BL17(?)L2	\$66
8'	19 #	BL19(?)L1	\$88	BL19(?)L2	\$76
10'	24 #	BL24(?)L1	\$109	BL24(?)L2	\$95
12'	29 #	BL29(?)L1	\$131	BL29(?)L2	\$114

- * Slat is 3 1/2" short of nominal length
- *(A) 2" mesh: 82 slats, (B) 2 1/4" mesh 78 slats, (C) 1 3/4" mesh: 100 slats per bag
- * 1 3/4" Mesh is your base (1-599) price plus 25% with no minimum quantity / No Returns.
- * Special colors > 50 bag min add 35%, 100 bags add 20% or 150 bags add 10% surcharge #PEXCTM
- * Extra Channel #EC 32¢/LF
- * Approximately 75% wind block
- * 25 year limited warranty

Top Lock					
Length	Weight	Item#	1-599	Item#	600-1199
3'	7 #	TL7(?)L1	\$39	TL7(?)L2	\$33
3.5'	8 #	TL8(?)L1	\$44	TL8(?)L2	\$38
4'	9 #	TL9(?)L1	\$44	TL9(?)L2	\$38
5'	12 #	TL12(?)L1	\$55	TL12(?)L2	\$47
6'	14 #	TL14(?)L1	\$66	TL14(?)L2	\$57
7'	17 #	TL17(?)L1	\$77	TL17(?)L2	\$66
8'	19 #	TL19(?)L1	\$88	TL19(?)L2	\$76
10'	24 #	TL24(?)L1	\$109	TL24(?)L2	\$95
12'	29 #	TL29(?)L1	\$131	TL29(?)L2	\$114

- * Slat is 2" short of nominal length
- *(A) 2" mesh: 82 slats, (B) 2 1/4" mesh 78 slats, (C) 1 3/4" mesh: 100 slats per bag
- * 2 1/4" and 1 3/4" mesh are base price (1-599) plus 25% with 50 bag min per color / No Returns.
- * Special colors > 50 bag min add 35%, 100 bags add 20% or 150 bags add 10% surcharge #PEXCTM
- * Extra Channel #EC 32¢/LF
- * 200ft Channel reel available #CR \$68/EA
- * Approximately 75% wind block
- * 25 year limited warranty

Winged Slat®					
Length	Weight	Item#	1-599	Item#	600-1199
3'	8 #	WS8L1	\$50	WS8L2	\$44
3.5'	9 #	WS9L1	\$57	WS9L2	\$50
4'	11 #	WS11L1	\$57	WS11L2	\$50
5'	13 #	WS13L1	\$72	WS13L2	\$62
6'	16 #	WS16L1	\$86	WS16L2	\$75
7'	18 #	WS18L1	\$100	WS18L2	\$87
8'	21 #	WS21L1	\$114	WS21L2	\$100

- * Slat is 2" short of nominal length / 82 slats per bag
- * For 9 or 11 gauge 2" mesh / Requires no Locking Channel
- * Fence of 8' or higher - double stack 1/2 heights
- * Special colors > 50 bag min add 35%, 100 bags add 20% or 150 bags add 10% surcharge #PEXCTM
- * Approximately 90% wind block
- * 25 year limited warranty

FinLink®					
Length	Weight	Item#	1-599	Item#	600-1199
3'	8 #	FL8L1	\$53	FL8L2	\$46
3.5'	9 #	FL9L1	\$60	FL9L2	\$52
4'	10 #	FL10L1	\$60	FL10L2	\$52
5'	12 #	FL12L1	\$75	FL12L2	\$65
6'	14 #	FL14L1	\$90	FL14L2	\$78
7'	16 #	FL16L1	\$105	FL16L2	\$91
8'	19 #	FL19L1	\$120	FL19L2	\$104

- * Slat is 3 1/2" short of nominal length
- * For 11 gauge 2" mesh ONLY - 82 slats per bag
- * Uses bottom channel for level installation
- * Extra Channel #EC 32¢/LF
- * Special colors > 50 bag min add 35%, 100 bags add 20% or 150 bags add 10% surcharge #PEXCTM
- * Approximately 90% wind block
- * 25 year limited warranty

LiteLink®					
Length	Weight	Item#	1-599	Item#	600-1199
3'	4 #	LL4L1	\$31	LL4L2	\$27
3.5'	5 #	LL5L1	\$35	LL5L2	\$31
4'	6 #	LL6L1	\$35	LL6L2	\$31
5'	7 #	LL7L1	\$44	LL7L2	\$38
6'	9 #	LL9L1	\$53	LL9L2	\$46
7'	10 #	LL10L1	\$61	LL10L2	\$53
8'	11 #	LL11L1	\$70	LL11L2	\$61
10'	14 #	LL14L1	\$87	LL14L2	\$76
12'	17 #	LL17L1	\$105	LL17L2	\$91

- * Slat is 3 1/2" short of nominal length
- * One size fits both 2" and 2 1/4" mesh - 82 pcs per box
- * Special colors > 50 box min add 35%, 100 boxes add 20% or 150 boxes add 10% surcharge #PEXCTM
- * Extra Channel #EC 32¢/LF
- * Approximately 75% wind block
- * 7 year limited warranty

HedgeLink®					
Length	Weight	Item#	1-599	Item#	600-1199
4'	17 #	HL17L1	\$112	HL17L2	\$103
5'	20 #	HL20L1	\$131	HL20L2	\$120
6'	25 #	HL25L1	\$160	HL25L2	\$146
7'	29 #	HL29L1	\$182	HL29L2	\$167
8'	33 #	HL33L1	\$204	HL33L2	\$187
10'	40 #	HL40L1	\$271	HL40L2	\$248

- * One size fits both 2" and 2 1/4" mesh
- * 10 linear feet per box / 82 Hedge-Slats per box
- * 16 gauge braided galvanized wire / 3-mil PVC green needles
- * DO NOT MIX Hedge-Link with any other hedge product
- * Approximately 95% wind block
- * 10 year limited warranty

Standard Colors*



YOUR "ONE-STOP" SOURCE FOR AMERICA'S BASEBALL, SOFTBALL & SPORTS SURFACES & SUPPLIES!

PRICES SUBJECT TO CHANGE & AVAILABILITY PLUS SHIPPING | VOLUME DISCOUNTS AVAILABLE | COOPERATIVE PURCHASING CONTRACT PRICING FOR 50 STATES

BEAM CLAY®

WHOLESALE PRICE LIST

Chain Link Fence Slats

BOTTOM LOCK



Bottom Lock utilizes our innovative bottom locking channel system providing a “snap-in” locking effect for security and deters vandalism at an affordable price.

Design: Bottom-Lock Slats are flat and tubular in shape, with two “legs” inside the rigid, hollow body of the slat, for extra durability.

Installation Instructions:

- Step 1** Insert locking channel horizontally in first full diamond at bottom of fence with open side facing up.
- Step 2** Insert vertical slats with beveled/notched end downward. Slat engages and interlocks with bottom rail.
- Step 3** Push the vertical slat into the horizontal channel to lock in place.

Standard Heights: 4, 5, 6, 7, 8, 10 and 12 feet. Special heights available upon request.

Wind Load and Privacy Factor: Approximately 75%.

Bottom-Locking Channel: 10 feet provided in each bag.

Slat Length: 3½” shorter than the overall height of fence.

Warranty: 25 years pro-rata.

SLAT PROFILE:



LOCKING CHANNEL:



Slat Type	Slat Width	Mesh Size	Wire Gauge	Slats Per Bag
Bottom Lock 2”	1 3/32”	2”	8, 9 or 11	82
Bottom Lock 2 1/4”	1 1/4”	2 1/4” or 2 3/8”	11 1/2 or 12 1/2	78
Bottom Lock 1 3/4”	7/8”	1 3/4”	8, 9 or 11	100
*Bottom Lock 1 3/4”	7/8”	2”	6	100

*Choosing this option will significantly decrease the privacy factor.

TOP LOCK



Top Lock utilizes a top-locking mechanism located near the top of the slats for easy installation and to ensure a clean, straight edge, enhancing its appearance.

Design: Top-Lock Slats are flat and tubular in shape, with circular, notched-out holes located near the top of the slat.

Installation Instructions:

- Step 1** No need to kneel, simply insert the slats vertically from top to bottom, keeping the locking holes on top.
- Step 2** Thread the flexible locking channel horizontally through the notched holes in the slats. These holes are elliptical to ensure they always stay open for fast and easy threading.
- Step 3** For extra security, insert a pop-rivet through locking channel and one slat.

Standard Heights: 4, 5, 6, 7, 8, 10 & 12 feet. Special heights available upon request.

Wind Load and Privacy Factor: Approximately 75%.

Top-Locking Channel: 10 feet provided in each bag.

Slat Length: 2” shorter than the overall height of fence.

Warranty: 25 years pro-rata.

SLAT PROFILE:



Slat Type	Slat Width	Mesh Size	Wire Gauge	Slats Per Bag
Top Lock 2”	1 3/32”	2”	8, 9 or 11	82
Top Lock 2 1/4”	1 1/4”	2 1/4” or 2 3/8”	11 1/2 or 12 1/2	78
Top Lock 1 3/4”	7/8”	1 3/4”	8, 9 or 11	100
*Top Lock 1 3/4”	7/8”	2”	6	100

*Choosing this option will significantly decrease the privacy factor.

YOUR “ONE-STOP” SOURCE FOR AMERICA’S BASEBALL, SOFTBALL & SPORTS SURFACES & SUPPLIES!

PRICES SUBJECT TO CHANGE & AVAILABILITY PLUS SHIPPING | VOLUME DISCOUNTS AVAILABLE | COOPERATIVE PURCHASING CONTRACT PRICING FOR 50 STATES

BEAM CLAY®

WHOLESALE PRICE LIST

Chain Link Fence Slats



With the proven quality and durability of our standard slats, plus unique flexible "wings" for extra screening and security, Winged Slats® are self-locking - no locking channels are needed!

Design: Our innovative Winged Slat has a rigid, flat-tubular body, with two "legs" inside the rigid, hollow body of the slat for extra support and durability. Flexible and resilient wing portions are positioned on each side of the slat body. Serrations are added to the wings for easier installation and locking power.

Installation Instructions: Insert vertical slats with angle cut end downward. Winged portion interlocks with chain link knuckles.

Standard Heights: 4, 5, 6, 7 and 8 feet.

Important: For Fence heights higher than 8 feet, we strongly advise **NOT** to double-stack Winged Slats®. If you double-stack, you will be at risk of the Winged Slats® not all giving the same visual appearance or giving the same privacy effect on the top and bottom portions of the Fence.

Wind Load and Privacy Factor: Approximately 90%. (Based on wire/mesh used - stretch tension)

Slat Length: 2" shorter than the overall height of fence.

Warranty: 25 years pro-rata.



Slat Type	Slat Width	Mesh Size	Wire Gauge	Slats Per Bag
Winged Slat®	1 3/8"	2"	9 only	82



The FinLink® slat offers extra screening and security with a unique configuration of (3) three privacy fins.

Design: Our unique innovative design includes a rigid, flat tubular body, with a "leg" inside the rigid, hollow body of the slat for extra support. Three flexible fins (two on one side and one on the other) are positioned on the sides of the slat body. The FinLink® fins are not serrated, thus providing a smooth finished look.

Installation Instructions:

Step 1 Insert locking channel horizontally in first full diamond at bottom of fence with open side facing up.

Step 2 Insert vertical slats with bevel end downward.

Step 3 Push the vertical slat into the horizontal channel until the slat touches the bottom of channel.

Standard Heights: 4, 5, 6, 7 and 8 feet.

Wind Load and Privacy Factor: Approximately 90%.

Bottom-Locking Channel: 10 feet provided in each bag.

Slat Length: 3 1/2" shorter than the overall height of fence.

Warranty: 25 years pro-rata.



Slat Type	Slat Width	Mesh Size	Wire Gauge	Slats Per Bag
FinLink®	1 3/8"	2", 2 1/4" or 2 3/8"	11	82

YOUR "ONE-STOP" SOURCE FOR AMERICA'S BASEBALL, SOFTBALL & SPORTS SURFACES & SUPPLIES!

PRICES SUBJECT TO CHANGE & AVAILABILITY PLUS SHIPPING | VOLUME DISCOUNTS AVAILABLE | COOPERATIVE PURCHASING CONTRACT PRICING FOR 50 STATES

BEAM CLAY®

WHOLESALE PRICE LIST

Chain Link Fence Slats



LiteLink® is a single wall "M" shaped slat that gives visual screening and color enhancement at our most affordable price. It also uses our innovative Bottom-Locking Channel system.

Design: Compact and lightweight, LiteLink®'s unique shape enables the slat to self stack. It comes packaged in a box (27" x 5" x Slat Length), making it easy to ship and efficient to store.

Installation Instructions:

- Step 1** Insert locking channel horizontally in first full diamond at bottom of fence with open side facing up.
- Step 2** Insert vertical slats with interlocking tab downward. Slat engages and interlocks with bottom rail.
- Step 3** Push the vertical slat into the horizontal channel to lock in place.

Standard Heights: 4, 5, 6, 7, 8, 10 and 12 feet. Special heights available upon request.

Wind Load and Privacy Factor: Approximately 75%.

Slat Length: 3/8" shorter than the overall height of fence.

Warranty: 7 years pro-rata.

SLAT PROFILE



Slat Type	Slat Width	Mesh Size	Wire Gauge	Slats Per Box
LiteLink®	1 1/4"	2", 2 1/4" or 2 3/8"	9, 11 or 11 1/2	82



HedgeLink® is our most premium and unique chain link fence enhancement product, which creates a natural green hedge look that requires no maintenance and offers almost complete privacy.

Design: The HedgeLink® core is made with a strong, rigid 16-gauge galvanized, braided wire. Blue Spruce colored 3-mil PVC needles are embossed for an extra plush effect.

Installation Instructions: Requires no locking device or tools and installs much like our Winged Slats®. Insert HedgeLink® slats vertically top to bottom, keeping the green needles facing up, while revolving the slat clockwise with your fingers for easier installation.

Standard Heights: 4, 5, 6, 7, and 8 feet.

Wind Load and Privacy Factor: Approximately 95%.

Fence Sizes: For most Chain Link Fence sizes. Not intended for use with mini-mesh or 3 1/2" x 5" fence fabric.

Features: UV stabilized to protect against the harmful rays of the sun. Flame retardant.

Note: Do not mix HedgeLink® with any other manufacturer's hedge product – color shades are different.

Warranty: 10 years pro-rata.

Slat Type	Mesh Size	Wire Gauge	Slats Per Box	Approx. Coverage Per Box
HedgeLink®	2", 2 1/4" or 2 3/8"	9, 11 or 11 1/2	82	10 linear ft

YOUR "ONE-STOP" SOURCE FOR AMERICA'S BASEBALL, SOFTBALL & SPORTS SURFACES & SUPPLIES!

PRICES SUBJECT TO CHANGE & AVAILABILITY PLUS SHIPPING | VOLUME DISCOUNTS AVAILABLE | COOPERATIVE PURCHASING CONTRACT PRICING FOR 50 STATES

Partac Peat Corporation – Item Price Schedule
Athletic Equipment & Supplies BID# ESCNJ 17/18-31 Effective 5/9/2018 - 5/8/2022

Bidding Company Name:				Partac Peat Corporation		Catalog Name:		114 - Fence Guards, Rail Padding & Fence Slats				No.	
No.	Product Category	Beam Clay Catalog Section #	Page#	Product Description	Manufacturer	Vendor SKU	Unit of Measure	Catalog List Price	Bid Discount Percentage	Discount Amt.	Net Effective Bid Price	Comments	No.
1	Baseball & Softball	114	2	PREMIUM FENCE GUARDS™ - 3" W x 4-1/2" H x 7' Long x .1" wall. SAFETY YELLOW. Twelve 7-foot sections per box (84').Includes ties.5-Year Limited Manufacturer's Warranty.	AER-FLO	#01166-YEL7	BOX	\$ 195.000	5.0%	\$ 9.750	\$ 185.250	+ shipping - see freight notes	1
2	Baseball & Softball	114	2	PREMIUM FENCE GUARDS™ - 3" W x 4-1/2" H x 7' Long x .1" wall. DARK GREEN. Twelve 7-foot sections per box (84'). Includes ties. 5-Year Limited Manufacturer's Warranty.	AER-FLO	#01166-GRN7	BOX	\$ 195.000	5.0%	\$ 9.750	\$ 185.250	+ shipping - see freight notes	2
3	Baseball & Softball	114	2	PREMIUM FENCE GUARDS™ - 3" W x 4-1/2" H x 7' Long x .1" wall. RED. Twelve 7-foot sections per box (84'). Includes ties.5-Year Limited Manufacturer's Warranty.	AER-FLO	#01166-RED7	BOX	\$ 195.000	5.0%	\$ 9.750	\$ 185.250	+ shipping - see freight notes	3
4	Baseball & Softball	114	2	PREMIUM FENCE GUARDS™ - 3" W x 4-1/2" H x 7' Long x .1" wall. BLUE. Twelve 7-foot sections per box (84'). Includes ties. 5-Year Limited Manufacturer's Warranty.	AER-FLO	#01166-BLU7	BOX	\$ 195.000	5.0%	\$ 9.750	\$ 185.250	+ shipping - see freight notes	4
5	Baseball & Softball	114	2	STANDARD FENCE GUARDS™ - 2-5/8" W x 4" H x 7' Long x .07" wall. SAFETY YELLOW. Includes ties. 3-Year Limited Manufacturer's Warranty.	AER-FLO	#01923-YEL7	BOX	\$ 145.000	5.0%	\$ 7.250	\$ 137.750	+ shipping - see freight notes	5
6	Baseball & Softball	114	2	STANDARD FENCE GUARDS™ - 2-5/8" W x 4" H x 7' Long x .07" wall. Dark Green. Includes ties. 3-Year Limited Manufacturer's Warranty.	AER-FLO	#01923-GRN7	BOX	\$ 145.000	5.0%	\$ 7.250	\$ 137.750	+ shipping - see freight notes	6
7	Baseball & Softball	114	2	STANDARD FENCE GUARDS™ - 2-5/8" W x 4" H x 7' Long x .07" wall. Red. Includes ties. 3-Year Limited Manufacturer's Warranty.	AER-FLO	#01923-RED7	BOX	\$ 145.000	5.0%	\$ 7.250	\$ 137.750	+ shipping - see freight notes	7
8	Baseball & Softball	114	2	STANDARD FENCE GUARDS™ - 2-5/8" W x 4" H x 7' Long x .07" wall. White. Includes ties. 3-Year Limited Manufacturer's Warranty.	AER-FLO	#01923-WHT7	BOX	\$ 145.000	5.0%	\$ 7.250	\$ 137.750	+ shipping - see freight notes	8
9	Baseball & Softball	114	2	STANDARD FENCE GUARDS™ - 2-5/8" W x 4" H x 7' Long x .07" wall. Blue. Includes ties. 3-Year Limited Manufacturer's Warranty.	AER-FLO	#01923-BLU7	BOX	\$ 145.000	5.0%	\$ 7.250	\$ 137.750	+ shipping - see freight notes	9
10	Baseball & Softball	114	2	STANDARD FENCE GUARDS™ - 2-5/8" W x 4" H x 7' Long x .07" wall. Orange. Includes ties. 3-Year Limited Manufacturer's Warranty.	AER-FLO	#01923-ORA7	BOX	\$ 145.000	5.0%	\$ 7.250	\$ 137.750	+ shipping - see freight notes	10
11	Baseball & Softball	114	2	LITE FENCE GUARDS™ - 2-5/8" W x 4" H x 7' Long x .05" wall. SAFETY YELLOW. Includes ties. 1-Year Limited Manufacturer's Warranty.	White Line	#03022-YEL7	BOX	\$ 120.000	5.0%	\$ 6.000	\$ 114.000	+ shipping - see freight notes	11
12	Baseball & Softball	114	2	LITE FENCE GUARDS™ - 2-5/8" W x 4" H x 7' Long x .05" wall. Dark Green. Includes ties. 1-Year Limited Manufacturer's Warranty.	White Line	#03022-GRN7	BOX	\$ 120.000	5.0%	\$ 6.000	\$ 114.000	+ shipping - see freight notes	12
13	Baseball & Softball	114	2	LITE FENCE GUARDS™ - 2-5/8" W x 4" H x 7' Long x .05" wall. Red. Includes ties. 1-Year Limited Manufacturer's Warranty.	White Line	#03022-RED7	BOX	\$ 129.000	5.0%	\$ 6.450	\$ 122.550	+ shipping - see freight notes	13
14	Baseball & Softball	114	2	8" Black UV-Resistant Ties - Packs of 100	AER-FLO	PT-8BK	PACK	\$ 10.000	5.0%	\$ 0.500	\$ 9.500	+ shipping - see freight notes	14
15	Baseball & Softball	114	3	250' Roll - ECONO GUARDS™ (POLY-CAP) - Orange - Corrugated poly in rolls, 4" ID x 4-5/8" OD x 1/16" (.0625") wall thickness. #06069	BALL FABRICS	06069	ROLL	\$ 235.000	5.0%	\$ 11.750	\$ 223.250	+ shipping - see freight notes	15
16	Baseball & Softball	114	3	250' Roll - ECONO GUARDS™ (POLY-CAP) - Black - Corrugated poly in rolls, 4" ID x 4-5/8" OD x 1/16" (.0625") wall thickness. #04449	BALL FABRICS	04449	ROLL	\$ 235.000	5.0%	\$ 11.750	\$ 223.250	+ shipping - see freight notes	16
17	Baseball & Softball	114	3	250' Roll - ECONO GUARDS™ (POLY-CAP) - Bright Safety Yellow - Corrugated poly in rolls, 4" ID x 4-5/8" OD x 1/16" (.0625") wall thickness. #01162	BALL FABRICS	01162	ROLL	\$ 235.000	5.0%	\$ 11.750	\$ 223.250	+ shipping - see freight notes	17
18	Baseball & Softball	114	3	250' Roll - ECONO GUARDS™ (POLY-CAP) - Dark Green - Corrugated poly in rolls, 4" ID x 4-5/8" OD x 1/16" (.0625") wall thickness. #02372	BALL FABRICS	02372	ROLL	\$ 235.000	5.0%	\$ 11.750	\$ 223.250	+ shipping - see freight notes	18
19	Baseball & Softball	114	3	250' Roll - ECONO GUARDS™ (POLY-CAP) - Red - Corrugated poly in rolls, 4" ID x 4-5/8" OD x 1/16" (.0625") wall thickness. #02141	BALL FABRICS	2141	ROLL	\$ 235.000	5.0%	\$ 11.750	\$ 223.250	+ shipping - see freight notes	19
20	Baseball & Softball	114	3	100' Roll - ECONO GUARDS™ (POLY-CAP) - Orange - Corrugated poly in rolls, 4" ID x 4-5/8" OD x 1/16" (.0625") wall thickness. #06070	BALL FABRICS	06070	ROLL	\$ 115.000	5.0%	\$ 5.750	\$ 109.250	+ shipping - see freight notes	20
21	Baseball & Softball	114	3	100' Roll - ECONO GUARDS™ (POLY-CAP) - Black - Corrugated poly in rolls, 4" ID x 4-5/8" OD x 1/16" (.0625") wall thickness. #04450	BALL FABRICS	04450	ROLL	\$ 115.000	5.0%	\$ 5.750	\$ 109.250	+ shipping - see freight notes	21
22	Baseball & Softball	114	3	100' Roll - ECONO GUARDS™ (POLY-CAP) - Bright Safety Yellow - Corrugated poly in rolls, 4" ID x 4-5/8" OD x 1/16" (.0625") wall thickness. #01160	BALL FABRICS	01160	ROLL	\$ 115.000	5.0%	\$ 5.750	\$ 109.250	+ shipping - see freight notes	22
23	Baseball & Softball	114	3	100' Roll - ECONO GUARDS™ (POLY-CAP) - Red - Corrugated poly in rolls, 4" ID x 4-5/8" OD x 1/16" (.0625") wall thickness. #02142	BALL FABRICS	2142	ROLL	\$ 115.000	5.0%	\$ 5.750	\$ 109.250	+ shipping - see freight notes	23

Bidding Company Name:				Partac Peat Corporation		Catalog Name:		114 - Fence Guards, Rail Padding & Fence Slats				No.	
No.	Product Category	Beam Clay Catalog Section #	Page#	Product Description	Manufacturer	Vendor SKU	Unit of Measure	Catalog List Price	Bid Discount Percentage	Discount Amt.	Net Effective Bid Price	Comments	No.
24	Baseball & Softball	114	3	100' Roll - ECONO GUARDS™ (POLY-CAP) - Dark Green - Corrugated poly in rolls, 4" ID x 4-5/8" OD x 1/16" (.0625") wall thickness. #02373	BALL FABRICS	02373	ROLL	\$ 115.000	5.0%	\$ 5.750	\$ 109.250	+ shipping - see freight notes	24
25	Baseball & Softball	114	3	18" Plastic Ties - Yellow - 100/Pack #01649	BALL FABRICS	01649	PACK	\$ 35.000	5.0%	\$ 1.750	\$ 33.250	+ shipping - see freight notes	25
#REF!	Baseball & Softball	114	3	18" Plastic Ties - Black - 100/Pack #04451	BALL FABRICS	#04451	PACK	\$ 35.000	5.0%	\$ 1.750	\$ 33.250	+ shipping - see freight notes	#REF!
#REF!	Baseball & Softball	114	3	250' Roll—FENCE CROWN® Safety Yellow - 4" ID x 4 1/2" OD. (250' to 1,500')	Humphry's	FC250Y	ROLL	\$ 175.000	5.0%	\$ 8.750	\$ 166.250	+ shipping - see freight notes	#REF!
#REF!	Baseball & Softball	114	3	250' Roll—FENCE CROWN® Black - 4" ID x 4 1/2" OD. (250' to 1,500')	Humphry's	FC250B	ROLL	\$ 175.000	5.0%	\$ 8.750	\$ 166.250	+ shipping - see freight notes	#REF!
#REF!	Baseball & Softball	114	3	250' Roll—FENCE CROWN® Safety Yellow - 4" ID x 4 1/2" OD. (more than 1,500')	Humphry's	FC250Y+	ROLL	\$ 165.000	5.0%	\$ 8.250	\$ 156.750	+ shipping - see freight notes	#REF!
#REF!	Baseball & Softball	114	3	250' Roll—FENCE CROWN® Black - 4" ID x 4 1/2" OD. (more than 1,500')	Humphry's	FC250B+	ROLL	\$ 165.000	5.0%	\$ 8.250	\$ 156.750	+ shipping - see freight notes	#REF!
#REF!	Baseball & Softball	114	3	100' Roll—FENCE CROWN® Safety Yellow - 4" ID x 4 1/2" OD. (100' to 1,500')	Humphry's	FC100Y	ROLL	\$ 100.000	5.0%	\$ 5.000	\$ 95.000	+ shipping - see freight notes	#REF!
#REF!	Baseball & Softball	114	3	100' Roll—FENCE CROWN® Black - 4" ID x 4 1/2" OD. (100' to 1,500')	Humphry's	FC100B	ROLL	\$ 100.000	5.0%	\$ 5.000	\$ 95.000	+ shipping - see freight notes	#REF!
#REF!	Baseball & Softball	114	3	100' Roll—FENCE CROWN® Safety Yellow - 4" ID x 4 1/2" OD. (more than 1,500')	Humphry's	FC100Y+	ROLL	\$ 95.000	5.0%	\$ 4.750	\$ 90.250	+ shipping - see freight notes	#REF!
#REF!	Baseball & Softball	114	3	100' Roll—FENCE CROWN® Black - 4" ID x 4 1/2" OD. (more than 1,500')	Humphry's	FC100B+	ROLL	\$ 95.000	5.0%	\$ 4.750	\$ 90.250	+ shipping - see freight notes	#REF!
#REF!	Baseball & Softball	114	3	Zipper Installation Tool #05072	Humphry's	05072	EACH	\$ 65.000	5.0%	\$ 3.250	\$ 61.750	+ shipping - see freight notes	#REF!
#REF!	Baseball & Softball	114	3	18" Plastic Ties - Black - 04451	Humphry's	04451	EACH	\$ 35.000	5.0%	\$ 1.750	\$ 33.250	+ shipping - see freight notes	#REF!
#REF!	Baseball & Softball	114	3	18" Plastic Ties - Yellow - 01649	Humphry's	01649	EACH	\$ 35.000	5.0%	\$ 1.750	\$ 33.250	+ shipping - see freight notes	#REF!
#REF!	Baseball & Softball	114	4	PREMIUM SAFETY TOP CAPS - SAFETY YELLOW - 40'/BAG 1—39 bags PSC-Y-L1	Pexco	PSC-Y-L1	BAG	\$ 105.000	5.0%				#REF! CALL FOR PRICE - EFFECTIVE 6/1/2021 DUE TO SUPPLY CHAIN ISSUES WE NEED TO EXCLUDE THIS PRODUCT LINE FROM ALL BIDS
#REF!	Baseball & Softball	114	4	PREMIUM SAFETY TOP CAPS - SAFETY YELLOW - 40'/BAG 40—119 bags PSC-Y-L2	Pexco	PSC-Y-L2	BAG	\$ 99.000	5.0%				#REF! CALL FOR PRICE - EFFECTIVE 6/1/2021 DUE TO SUPPLY CHAIN ISSUES WE NEED TO EXCLUDE THIS PRODUCT LINE FROM ALL BIDS
#REF!	Baseball & Softball	114	4	PREMIUM SAFETY TOP CAPS - SAFETY YELLOW - 40'/BAG 120+ bags PSC-Y-L3	Pexco	PSC-Y-L3	BAG	\$ 91.000	5.0%				#REF! CALL FOR PRICE - EFFECTIVE 6/1/2021 DUE TO SUPPLY CHAIN ISSUES WE NEED TO EXCLUDE THIS PRODUCT LINE FROM ALL BIDS
#REF!	Baseball & Softball	114	4	PREMIUM SAFETY TOP CAPS - BLACK - 40'/BAG 1—39 bags PSC-B-L1	Pexco	PSC-B-L1	BAG	\$ 125.000	5.0%				#REF! CALL FOR PRICE - EFFECTIVE 6/1/2021 DUE TO SUPPLY CHAIN ISSUES WE NEED TO EXCLUDE THIS PRODUCT LINE FROM ALL BIDS
#REF!	Baseball & Softball	114	4	PREMIUM SAFETY TOP CAPS - 10 STANDARD COLORS—Dark Green, Royal Blue, Sky Blue, Red, Redwood, Brown, Beige, Grey, Black, or White. 1600' minimum (40/40 bags) order, 4-6 weeks lead time, no returns. PSC-SC-L3	Pexco	PSC-SC-L3	BAG	\$ 125.000	5.0%				#REF! CALL FOR PRICE - EFFECTIVE 6/1/2021 DUE TO SUPPLY CHAIN ISSUES WE NEED TO EXCLUDE THIS PRODUCT LINE FROM ALL BIDS
#REF!	Baseball & Softball	114	4	PREMIUM SAFETY TOP CAPS - CUSTOM COLORS - 1600' minimum (40/40 bags) order, 6-8 weeks lead time, no returns. PSC-CC-L3	Pexco	PSC-CC-L3	BAG	\$ 155.000	5.0%				#REF! CALL FOR PRICE - EFFECTIVE 6/1/2021 DUE TO SUPPLY CHAIN ISSUES WE NEED TO EXCLUDE THIS PRODUCT LINE FROM ALL BIDS
#REF!	Baseball & Softball	114	4	SAFETY TOP CAP—LITE - SAFETY YELLOW - 80'/BAG 1—39 bags STCL-Y-L1	Pexco	STCL-Y-L1	BAG	\$ 103.000	5.0%				#REF! CALL FOR PRICE - EFFECTIVE 6/1/2021 DUE TO SUPPLY CHAIN ISSUES WE NEED TO EXCLUDE THIS PRODUCT LINE FROM ALL BIDS
#REF!	Baseball & Softball	114	4	SAFETY TOP CAP—LITE - SAFETY YELLOW - 80'/BAG 40—119 bags STCL-Y-L2	Pexco	STCL-Y-L2	BAG	\$ 97.000	5.0%				#REF! CALL FOR PRICE - EFFECTIVE 6/1/2021 DUE TO SUPPLY CHAIN ISSUES WE NEED TO EXCLUDE THIS PRODUCT LINE FROM ALL BIDS
#REF!	Baseball & Softball	114	4	SAFETY TOP CAP—LITE - SAFETY YELLOW - 80'/BAG 120+ bags STCL-Y-L3	Pexco	STCL-Y-L3	BAG	\$ 89.000	5.0%				#REF! CALL FOR PRICE - EFFECTIVE 6/1/2021 DUE TO SUPPLY CHAIN ISSUES WE NEED TO EXCLUDE THIS PRODUCT LINE FROM ALL BIDS

Bidding Company Name:				Partac Peat Corporation		Catalog Name:		114 - Fence Guards, Rail Padding & Fence Slats				No.		
No.	Product Category	Beam Clay Catalog Section #	Page#	Product Description	Manufacturer	Vendor SKU	Unit of Measure	Catalog List Price	Bid Discount Percentage	Discount Amt.	Net Effective Bid Price	Comments	No.	
#REF!	Baseball & Softball	114	4	SAFETY TOP CAP—LITE - BLACK - 80'/BAG 1—39 bags STCL-B-L1	Pexco	STCL-B-L1	BAG	\$ 120.000	5.0%				#REF!	CALL FOR PRICE - EFFECTIVE 6/1/2021 DUE TO SUPPLY CHAIN ISSUES WE NEED TO EXCLUDE THIS PRODUCT LINE FROM ALL BIDS
#REF!	Baseball & Softball	114	4	SAFETY TOP CAP—LITE - 10 STANDARD COLORS—Dark Green, Royal Blue, Sky Blue, Red, Redwood, Brown, Beige, Grey, Black, or White. 3,200' minimum - (80' - 40 bags) order, 4-6 weeks lead time, no returns. STCLSC-L3	Pexco	STCLSC-L3	BAG	\$ 120.000	5.0%				#REF!	CALL FOR PRICE - EFFECTIVE 6/1/2021 DUE TO SUPPLY CHAIN ISSUES WE NEED TO EXCLUDE THIS PRODUCT LINE FROM ALL BIDS
#REF!	Baseball & Softball	114	4	SAFETY TOP CAP—LITE - CUSTOM COLORS - 3,200' minimum (80' - 40 bags) order, 6-8 weeks lead time, no returns. STCL-CC-L3	Pexco	STCL-CC-L3	BAG	\$ 145.000	5.0%				#REF!	CALL FOR PRICE - EFFECTIVE 6/1/2021 DUE TO SUPPLY CHAIN ISSUES WE NEED TO EXCLUDE THIS PRODUCT LINE FROM ALL BIDS
#REF!	Baseball & Softball	114	5	PREMIUM FOAM GUARDS - 1-19 (8') Lengths - Yellow, Green, Red, Royal Blue, Sky Blue, Black, Grey, Purple, 3-5/8" O.D. x 2-1/8" I.D. x 3/4" wall thickness. Yellow in stock. Other colors are custom ordered. P-SF1-19	Humphry's	P-SF1-19	LENGTH	\$ 41.000	5.0%	\$ 2.050	\$ 38.950	+ shipping - see freight notes	#REF!	
#REF!	Baseball & Softball	114	5	PREMIUM FOAM GUARDS - 20 or More (8') Lengths - Yellow, Green, Red, Royal Blue, Sky Blue, Black, Grey, Purple, 3-5/8" O.D. x 2-1/8" I.D. x 3/4" wall thickness. Yellow in stock. Other colors are custom ordered. P-SF-20+	Humphry's	P-SF-20+	LENGTH	\$ 37.000	5.0%	\$ 1.850	\$ 35.150	+ shipping - see freight notes	#REF!	
#REF!	Baseball & Softball	114	5	STANDARD FOAM GUARDS - Yellow - 2" Wall Thickness 1-19 (8') Lengths SFG2-1-19	Humphry's	SFG2-1-19	LENGTH	\$ 37.000	5.0%	\$ 1.850	\$ 35.150	+ shipping - see freight notes	#REF!	
#REF!	Baseball & Softball	114	5	STANDARD FOAM GUARDS - Yellow - 2" Wall Thickness 20 or More (8') Lengths SFG-20+	Humphry's	SFG2-20+	LENGTH	\$ 32.000	5.0%	\$ 1.600	\$ 30.400	+ shipping - see freight notes	#REF!	
#REF!	Baseball & Softball	114	5	19" Plastic Ties - Yellow - 100/Pack 19TIESY	Humphry's	#19TIESY	PACK	\$ 25.000	5.0%	\$ 1.250	\$ 23.750	+ shipping - see freight notes	#REF!	
#REF!	Baseball & Softball	114	5	19" Plastic Ties - Black - 100/Pack 19TIESB	Humphry's	#19TIESB	PACK	\$ 25.000	5.0%	\$ 1.250	\$ 23.750	+ shipping - see freight notes	#REF!	
#REF!	Baseball & Softball	114	5	24" Plastic Ties - Natural/Off White for 2" Pads - 100/Pack 24TIESN	Humphry's	#24TIESN	PACK	\$ 30.000	5.0%	\$ 1.500	\$ 28.500	+ shipping - see freight notes	#REF!	
#REF!	Baseball & Softball	114	6	Chain Link Fence Top Rail Post Pad, 3" Foam, 9" face, 6" top, 1-1/2" flaps, grommets every 6" #CLTR	SS	#CLTR	LF	\$ 36.000	5.0%	\$ 1.800	\$ 34.200	+ shipping - see freight notes	#REF!	
#REF!	Baseball & Softball	114	6	Chain Link Fence Post Pad--Horizontal, 3" Foam, 6" wide with 1-1/2" flaps, grommets every 6" #CLPH	SS	#CLPH	LF	\$ 26.000	5.0%	\$ 1.300	\$ 24.700	+ shipping - see freight notes	#REF!	
#REF!	Baseball & Softball	114	6	Chain Link Fence Post Pad--Vertical, 3" Foam, 6" wide with 1-1/2" flaps, grommets every 6" #CLPV	SS	#CLPV	LF	\$ 26.000	5.0%	\$ 1.300	\$ 24.700	+ shipping - see freight notes	#REF!	
#REF!	Baseball & Softball	114	6	RAIL GUARDS DUGOUT RAIL PADDING - 1" thick closed-cell polyethylene foam encased in 18 oz. vinyl with grommets every 6" for attachment to up to 3" diameter railing. Colors: Maple Green, Royal Blue, Red, Navy Blue, Gray, Maroon, Sky Blue, Purple, Yellow, White, Tan, Black, Kelly Green, Orange. RG1	Humphry's	RG1	LF	\$ 24.950	5.0%	\$ 1.248	\$ 23.703	+ shipping - see freight notes	#REF!	
#REF!	Baseball & Softball	114	6	RAIL GUARDS DUGOUT RAIL PADDING - 2" thick closed-cell polyethylene foam encased in 18 oz. vinyl with grommets every 6" for attachment to up to 3" diameter railing. Colors: Maple Green, Royal Blue, Red, Navy Blue, Gray, Maroon, Sky Blue, Purple, Yellow, White, Tan, Black, Kelly Green, Orange. RG2	Humphry's	RG2	LF	\$ 27.950	5.0%	\$ 1.398	\$ 26.553	+ shipping - see freight notes	#REF!	
#REF!	Baseball & Softball	114	7	AER-CUSHION FLAT RAIL PADDING - Open Cell Foam Encased in 18 oz Vinyl - 18 Colors, Grommets spaced every 8": 1" THICK FOAM X 6" WIDE (TO FIT UP TO 1" DIA. POLE) 16FRP	AER-FLO	16FRP	LF	\$ 16.000	5.0%	\$ 0.800	\$ 15.200	+ shipping - see freight notes	#REF!	
#REF!	Baseball & Softball	114	7	AER-CUSHION FLAT RAIL PADDING - Open Cell Foam Encased in 18 oz Vinyl - 18 Colors, Grommets spaced every 8": 1" THICK POLYFOAM X 7" WIDE (TO FIT UP TO 1.5" DIA. POLE) 17FRP	AER-FLO	17FRP	LF	\$ 16.250	5.0%	\$ 0.813	\$ 15.438	+ shipping - see freight notes	#REF!	
#REF!	Baseball & Softball	114	7	AER-CUSHION FLAT RAIL PADDING - Open Cell Foam Encased in 18 oz Vinyl - 18 Colors, Grommets spaced every 8": 1" THICK POLYFOAM X 8" WIDE (TO FIT UP TO 2" DIA. POLE) 18FRP	AER-FLO	18FRP	LF	\$ 16.350	5.0%	\$ 0.818	\$ 15.533	+ shipping - see freight notes	#REF!	
#REF!	Baseball & Softball	114	7	AER-CUSHION FLAT RAIL PADDING - Open Cell Foam Encased in 18 oz Vinyl - 18 Colors, Grommets spaced every 8": 1" THICK POLYFOAM X 9" WIDE (TO FIT UP TO 3" DIA. POLE) 19FRP	AER-FLO	19FRP	LF	\$ 16.350	5.0%	\$ 0.818	\$ 15.533	+ shipping - see freight notes	#REF!	
#REF!	Baseball & Softball	114	7	AER-CUSHION FLAT RAIL PADDING - Open Cell Foam Encased in 18 oz Vinyl - 18 Colors, Grommets spaced every 8": 1" THICK POLYFOAM X 10" WIDE (TO FIT UP TO 3.5" DIA. POLE) 110FRP	AER-FLO	110FRP	LF	\$ 16.350	5.0%	\$ 0.818	\$ 15.533	+ shipping - see freight notes	#REF!	
#REF!	Baseball & Softball	114	7	AER-CUSHION FLAT RAIL PADDING - Open Cell Foam Encased in 18 oz Vinyl - 18 Colors, Grommets spaced every 8": 2" THICK POLYFOAM X 6" WIDE (TO FIT UP TO 1" DIA. POLE) 26FRP	AER-FLO	26FRP	LF	\$ 16.350	5.0%	\$ 0.818	\$ 15.533	+ shipping - see freight notes	#REF!	
#REF!	Baseball & Softball	114	7	AER-CUSHION FLAT RAIL PADDING - Open Cell Foam Encased in 18 oz Vinyl - 18 Colors, Grommets spaced every 8": 2" THICK POLYFOAM X 7" WIDE (TO FIT UP TO 1.5" DIA. POLE) 27FRP	AER-FLO	27FRP	LF	\$ 16.450	5.0%	\$ 0.823	\$ 15.628	+ shipping - see freight notes	#REF!	
#REF!	Baseball & Softball	114	7	AER-CUSHION FLAT RAIL PADDING - Open Cell Foam Encased in 18 oz Vinyl - 18 Colors, Grommets spaced every 8": 2" THICK POLYFOAM X 8" WIDE (TO FIT UP TO 2" DIA. POLE) 28FRP	AER-FLO	28FRP	LF	\$ 15.650	5.0%	\$ 0.783	\$ 14.868	+ shipping - see freight notes	#REF!	

Bidding Company Name:				Partac Peat Corporation		Catalog Name:		114 - Fence Guards, Rail Padding & Fence Slats					No.
No.	Product Category	Beam Clay Catalog Section #	Page#	Product Description	Manufacturer	Vendor SKU	Unit of Measure	Catalog List Price	Bid Discount Percentage	Discount Amt.	Net Effective Bid Price	Comments	No.
#REF!	Baseball & Softball	114	7	AER-CUSHION FLAT RAIL PADDING - Open Cell Foam Encased in 18 oz Vinyl - 18 Colors, Grommets spaced every 8": 2" THICK POLYFOAM X 9" WIDE (TO FIT UP TO 3" DIA. POLE) 29FRP	AER-FLO	29FRP	LF	\$ 16.750	5.0%	\$ 0.838	\$ 15.913	+ shipping - see freight notes	#REF!
#REF!	Baseball & Softball	114	7	AER-CUSHION FLAT RAIL PADDING - Open Cell Foam Encased in 18 oz Vinyl - 18 Colors, Grommets spaced every 8": 2" THICK POLYFOAM X 10" WIDE (TO FIT UP TO 3.5" DIA. POLE) 210FRP	AER-FLO	210FRP	LF	\$ 17.350	5.0%	\$ 0.868	\$ 16.483	+ shipping - see freight notes	#REF!
#REF!	Baseball & Softball	114	7	CHROMA-BOND IMPRINTING 1 COLOR LOGO ONLY - UP TO 25SF - 1COL25SF	Aer-Flo	1COL25SF	EACH	\$ 550.000	5.0%	\$ 27.500	\$ 522.500	+ shipping - see freight notes	#REF!
#REF!	Baseball & Softball	114	7	CHROMA-BOND IMPRINTING 1 COLOR LOGO ONLY - 26SF-50SF - 1COL2650SF	Aer-Flo	1COL2650SF	EACH	\$ 725.000	5.0%	\$ 36.250	\$ 688.750	+ shipping - see freight notes	#REF!
#REF!	Baseball & Softball	114	7	CHROMA-BOND IMPRINTING 1 COLOR LOGO ONLY - 51SF-100SF - 1COL51100SF	Aer-Flo	1COL51100SF	EACH	\$ 995.000	5.0%	\$ 49.750	\$ 945.250	+ shipping - see freight notes	#REF!
#REF!	Baseball & Softball	114	7	CHROMA-BOND IMPRINTING 2 COLOR LOGO ONLY - UP TO 25SF - 2COL25SF	Aer-Flo	2COL25SF	EACH	\$ 675.000	5.0%	\$ 33.750	\$ 641.250	+ shipping - see freight notes	#REF!
#REF!	Baseball & Softball	114	7	CHROMA-BOND IMPRINTING 2 COLOR LOGO ONLY - 26SF-50SF - 2COL2650SF	Aer-Flo	2COL2650SF	EACH	\$ 850.000	5.0%	\$ 42.500	\$ 807.500	+ shipping - see freight notes	#REF!
#REF!	Baseball & Softball	114	7	CHROMA-BOND IMPRINTING 2 COLOR LOGO ONLY - 51SF-100SF - 2COL51100SF	Aer-Flo	2COL51100SF	EACH	\$ 1,150.000	5.0%	\$ 57.500	\$ 1,092.500	+ shipping - see freight notes	#REF!
#REF!	Baseball & Softball	114	7	CHROMA-BOND IMPRINTING 3 COLOR LOGO ONLY - UP TO 25SF - 3COL25SF	Aer-Flo	3COL25SF	EACH	\$ 760.000	5.0%	\$ 38.000	\$ 722.000	+ shipping - see freight notes	#REF!
#REF!	Baseball & Softball	114	7	CHROMA-BOND IMPRINTING 3 COLOR LOGO ONLY - 26SF-50SF - 3COL2650SF	Aer-Flo	3COL2650SF	EACH	\$ 925.000	5.0%	\$ 46.250	\$ 878.750	+ shipping - see freight notes	#REF!
#REF!	Baseball & Softball	114	7	CHROMA-BOND IMPRINTING 3 COLOR LOGO ONLY - 51SF-100SF - 3COL51100SF	Aer-Flo	3COL51100SF	EACH	\$ 1,215.000	5.0%	\$ 60.750	\$ 1,154.250	+ shipping - see freight notes	#REF!
#REF!	Baseball & Softball	114	7	CHROMA-BOND IMPRINTING 1 COLOR LTRS. OR NUMBERS - UP TO 24" TALL - 1COL24	Aer-Flo	1COL24	EACH	\$ 56.000	5.0%	\$ 2.800	\$ 53.200	+ shipping - see freight notes	#REF!
#REF!	Baseball & Softball	114	7	CHROMA-BOND IMPRINTING 1 COLOR LTRS. OR NUMBERS - UP TO 36" TALL - 1COL36	Aer-Flo	1COL36	EACH	\$ 68.000	5.0%	\$ 3.400	\$ 64.600	+ shipping - see freight notes	#REF!
#REF!	Baseball & Softball	114	7	CHROMA-BOND IMPRINTING 1 COLOR LTRS. OR NUMBERS - UP TO 48" TALL - 1COL48	Aer-Flo	1COL48	EACH	\$ 84.000	5.0%	\$ 4.200	\$ 79.800	+ shipping - see freight notes	#REF!
#REF!	Baseball & Softball	114	7	CHROMA-BOND IMPRINTING 1 COLOR LTRS. OR NUMBERS - UP TO 60" TALL - 1COL60	Aer-Flo	1COL60	EACH	\$ 98.000	5.0%	\$ 4.900	\$ 93.100	+ shipping - see freight notes	#REF!
#REF!	Baseball & Softball	114	7	CHROMA-BOND IMPRINTING 1 COLOR LTRS. OR NUMBERS - UP TO 72" TALL - 1COL72	Aer-Flo	1COL72	EACH	\$ 120.000	5.0%	\$ 6.000	\$ 114.000	+ shipping - see freight notes	#REF!
#REF!	Baseball & Softball	114	7	CHROMA-BOND IMPRINTING 1 COLOR LTRS. OR NUMBERS - UP TO 84" TALL - 1COL84	Aer-Flo	1COL84	EACH	\$ 131.000	5.0%	\$ 6.550	\$ 124.450	+ shipping - see freight notes	#REF!
#REF!	Baseball & Softball	114	7	CHROMA-BOND IMPRINTING 1 COLOR LTRS. OR NUMBERS - UP TO 96" TALL - 1COL96	Aer-Flo	1COL96	EACH	\$ 150.000	5.0%	\$ 7.500	\$ 142.500	+ shipping - see freight notes	#REF!
#REF!	Baseball & Softball	114	7	CHROMA-BOND IMPRINTING 1 COLOR LTRS. OR NUMBERS - UP TO 108" TALL - 1COL108	Aer-Flo	1COL108	EACH	\$ 178.000	5.0%	\$ 8.900	\$ 169.100	+ shipping - see freight notes	#REF!
#REF!	Baseball & Softball	114	7	CHROMA-BOND IMPRINTING 1 COLOR LTRS. OR NUMBERS - UP TO 120" TALL - 1COL120	Aer-Flo	1COL120	EACH	\$ 206.000	5.0%	\$ 10.300	\$ 195.700	+ shipping - see freight notes	#REF!
#REF!	Baseball & Softball	114	7	CHROMA-BOND IMPRINTING 2 COLOR LTRS. OR NUMBERS - UP TO 24" TALL - 2COL24	Aer-Flo	2COL24	EACH	\$ 76.000	5.0%	\$ 3.800	\$ 72.200	+ shipping - see freight notes	#REF!
#REF!	Baseball & Softball	114	7	CHROMA-BOND IMPRINTING 2 COLOR LTRS. OR NUMBERS - UP TO 36" TALL - 2COL36	Aer-Flo	2COL36	EACH	\$ 88.000	5.0%	\$ 4.400	\$ 83.600	+ shipping - see freight notes	#REF!
#REF!	Baseball & Softball	114	7	CHROMA-BOND IMPRINTING 2 COLOR LTRS. OR NUMBERS - UP TO 48" TALL - 2COL48	Aer-Flo	2COL48	EACH	\$ 104.000	5.0%	\$ 5.200	\$ 98.800	+ shipping - see freight notes	#REF!

Bidding Company Name:				Partac Peat Corporation		Catalog Name:		114 - Fence Guards, Rail Padding & Fence Slats					No.
No.	Product Category	Beam Clay Catalog Section #	Page#	Product Description	Manufacturer	Vendor SKU	Unit of Measure	Catalog List Price	Bid Discount Percentage	Discount Amt.	Net Effective Bid Price	Comments	No.
#REF!	Baseball & Softball	114	7	CHROMA-BOND IMPRINTING 2 COLOR LTRS. OR NUMBERS - UP TO 60" TALL - 2COL60	Aer-Flo	2COL60	EACH	\$ 118.000	5.0%	\$ 5.900	\$ 112.100	+ shipping - see freight notes	#REF!
#REF!	Baseball & Softball	114	7	CHROMA-BOND IMPRINTING 2 COLOR LTRS. OR NUMBERS - UP TO 72" TALL - 2COL72	Aer-Flo	2COL72	EACH	\$ 139.000	5.0%	\$ 6.950	\$ 132.050	+ shipping - see freight notes	#REF!
#REF!	Baseball & Softball	114	7	CHROMA-BOND IMPRINTING 2 COLOR LTRS. OR NUMBERS - UP TO 84" TALL - 2COL84	Aer-Flo	2COL84	EACH	\$ 151.000	5.0%	\$ 7.550	\$ 143.450	+ shipping - see freight notes	#REF!
#REF!	Baseball & Softball	114	7	CHROMA-BOND IMPRINTING 2 COLOR LTRS. OR NUMBERS - UP TO 96" TALL - 2COL96	Aer-Flo	2COL96	EACH	\$ 171.000	5.0%	\$ 8.550	\$ 162.450	+ shipping - see freight notes	#REF!
#REF!	Baseball & Softball	114	7	CHROMA-BOND IMPRINTING 2 COLOR LTRS. OR NUMBERS - UP TO 108" TALL - 2COL108	Aer-Flo	2COL108	EACH	\$ 198.000	5.0%	\$ 9.900	\$ 188.100	+ shipping - see freight notes	#REF!
#REF!	Baseball & Softball	114	7	CHROMA-BOND IMPRINTING 2 COLOR LTRS. OR NUMBERS - UP TO 120" TALL - 2COL120	Aer-Flo	2COL120	EACH	\$ 226.000	5.0%	\$ 11.300	\$ 214.700	+ shipping - see freight notes	#REF!
#REF!	Baseball & Softball	114	7	U-Shaped Pad #WBUSHAPEX	Aer-Flo	#WBUSHAPEX	LF	\$ 32.000	5.0%	\$ 1.600	\$ 30.400	+ shipping - see freight notes	#REF!
#REF!	Baseball & Softball	114	7	Flat Pad #WBFLAT	Aer-Flo	#WBFLAT	LF	\$ 21.500	5.0%	\$ 1.075	\$ 20.425	+ shipping - see freight notes	#REF!
#REF!	Baseball & Softball	114	7	Hardware for U-Shaped Pad #WBUSHAPEHARDWARE	Aer-Flo	#WBUSHAPEHARDWARE	SET	\$ 9.000	5.0%	\$ 0.450	\$ 8.550	+ shipping - see freight notes	#REF!
#REF!	Baseball & Softball	114	7	Hardware for Flat Pad #WBFLATHARDWARE	Aer-Flo	#WBFLATHARDWARE	SET	\$ 1.850	5.0%	\$ 0.093	\$ 1.758	+ shipping - see freight notes	#REF!
#REF!	Baseball & Softball	114	7	Velcro Wrap #VELCROWRAP	Aer-Flo	#VELCROWRAP	LF	\$ 7.000	5.0%	\$ 0.350	\$ 6.650	+ shipping - see freight notes	#REF!
#REF!	Baseball & Softball	114	8	DO-IT-YOURSELF TOP RAIL/DUGOUT PADDING. 4" Foam Diameter (To fit up to 1"- 1-5/8" Dia. Pole) #BF4RP	Ball Fabrics	BF4RP	LF	\$ 15.000	5.0%	\$ 0.750	\$ 14.250	+ shipping - see freight notes	#REF!
#REF!	Baseball & Softball	114	8	DO-IT-YOURSELF TOP RAIL/DUGOUT PADDING. 4.5" Foam Diameter (To fit up to 2"- 2-1/2" Dia. Pole) #BF45RP	Ball Fabrics	BF45RP	LF	\$ 17.500	5.0%	\$ 0.875	\$ 16.625	+ shipping - see freight notes	#REF!
#REF!	Baseball & Softball	114	8	DO-IT-YOURSELF TOP RAIL/DUGOUT PADDING. 5" Foam Diameter (To fit up to 2-1/2" - 3" Dia. Pole) #BF5RP	Ball Fabrics	BF5RP	LF	\$ 20.000	5.0%	\$ 1.000	\$ 19.000	+ shipping - see freight notes	#REF!
#REF!	Baseball & Softball	114	8	DO-IT-YOURSELF TOP RAIL/DUGOUT PADDING. 5.5" Foam Diameter (To fit up to 3" - 3-1/2" Dia. Pole) #BF55RP	Ball Fabrics	BF55RP	LF	\$ 23.500	5.0%	\$ 1.175	\$ 22.325	+ shipping - see freight notes	#REF!
#REF!	Baseball & Softball	114	8	DO-IT-YOURSELF TOP RAIL/DUGOUT PADDING. #60 Lacing Twine 300' Spool #LT300	Ball Fabrics	LT300	EACH	\$ 25.000	5.0%	\$ 1.250	\$ 23.750	+ shipping - see freight notes	#REF!
#REF!	Baseball & Softball	114	8	DO-IT-YOURSELF TOP RAIL/DUGOUT PADDING. 7-1/2" 50 lb. UV-Resistant Black Plastic Ties (Packs of 100) #PT-7.5BK	Ball Fabrics	PT-7.5BK	PACK	\$ 10.000	5.0%	\$ 0.500	\$ 9.500	+ shipping - see freight notes	#REF!
#REF!	Baseball & Softball	114	8	DO-IT-YOURSELF TOP RAIL/DUGOUT PADDING. 8" 120 lb. Heavy-Duty UV-Resistant Black Plastic Ties (Packs of 100) #PT-HD8BK	Ball Fabrics	PT-HD8BK	PACK	\$ 15.000	5.0%	\$ 0.750	\$ 14.250	+ shipping - see freight notes	#REF!
#REF!	Baseball & Softball	114	10	Bottom Lock Privacy Decorative Slats for Chainlink Fencing - 2" mesh, 82 slats, *3.5"L, 7 lbs., BL7AL1 Standard colors: white, green, brown, black, beige, gray, redwood, royal blue, or light blue (1-599 Bags)	Pexco	BL7AL1	Bag	\$ 39.000	5.0%				CALL FOR PRICE - EFFECTIVE 6/1/2021 DUE TO SUPPLY CHAIN ISSUES WE NEED TO EXCLUDE THIS PRODUCT LINE FROM ALL BIDS
#REF!	Baseball & Softball	114	10	Bottom Lock Privacy Decorative Slats for Chainlink Fencing - 2" mesh, 82 slats, *3.5"L, 8 lbs., BL8AL1 Standard colors: white, green, brown, black, beige, gray, redwood, royal blue, or light blue (1-599 Bags)	Pexco	BL8AL1	BAG	\$ 44.000	5.0%				CALL FOR PRICE - EFFECTIVE 6/1/2021 DUE TO SUPPLY CHAIN ISSUES WE NEED TO EXCLUDE THIS PRODUCT LINE FROM ALL BIDS
#REF!	Baseball & Softball	114	10	Bottom Lock Privacy Decorative Slats for Chainlink Fencing - 2" mesh, 82 slats, *4"L, 9 lbs., BL9AL1 Standard colors: white, green, brown, black, beige, gray, redwood, royal blue, or light blue (1-599 Bags)	Pexco	BL9AL1	BAG	\$ 44.000	5.0%				CALL FOR PRICE - EFFECTIVE 6/1/2021 DUE TO SUPPLY CHAIN ISSUES WE NEED TO EXCLUDE THIS PRODUCT LINE FROM ALL BIDS
#REF!	Baseball & Softball	114	10	Bottom Lock Privacy Decorative Slats for Chainlink Fencing - 2" mesh, 82 slats, *5"L, 12 lbs., BL12AL1 Standard colors: white, green, brown, black, beige, gray, redwood, royal blue, or light blue (1-599 Bags)	Pexco	BL12AL1	BAG	\$ 55.000	5.0%				CALL FOR PRICE - EFFECTIVE 6/1/2021 DUE TO SUPPLY CHAIN ISSUES WE NEED TO EXCLUDE THIS PRODUCT LINE FROM ALL BIDS
#REF!	Baseball & Softball	114	10	Bottom Lock Privacy Decorative Slats for Chainlink Fencing - 2" mesh, 82 slats, *6"L, 14 lbs., BL14AL1 Standard colors: white, green, brown, black, beige, gray, redwood, royal blue, or light blue (1-599 Bags)	Pexco	BL14AL1	BAG	\$ 66.000	5.0%				CALL FOR PRICE - EFFECTIVE 6/1/2021 DUE TO SUPPLY CHAIN ISSUES WE NEED TO EXCLUDE THIS PRODUCT LINE FROM ALL BIDS
#REF!	Baseball & Softball	114	10	Bottom Lock Privacy Decorative Slats for Chainlink Fencing - 2" mesh, 82 slats, *7"L, 17 lbs., BL17AL1 Standard colors: white, green, brown, black, beige, gray, redwood, royal blue, or light blue (1-599 Bags)	Pexco	BL17AL1	BAG	\$ 77.000	5.0%				CALL FOR PRICE - EFFECTIVE 6/1/2021 DUE TO SUPPLY CHAIN ISSUES WE NEED TO EXCLUDE THIS PRODUCT LINE FROM ALL BIDS

Bidding Company Name:				Partac Peat Corporation	Catalog Name:		114 - Fence Guards, Rail Padding & Fence Slats					No.	
No.	Product Category	Beam Clay Catalog Section #	Page#	Product Description	Manufacturer	Vendor SKU	Unit of Measure	Catalog List Price	Bid Discount Percentage	Discount Amt.	Net Effective Bid Price	Comments	No.
#REF!	Baseball & Softball	114	19	Bottom Lock Privacy Decorative Slats for Chainlink Fencing - 2" mesh, *8'L, 19 lbs., BL19AL1 Standard colors: white, green, brown, black, beige, gray, redwood, royal blue, or light blue (1-599 Bags)	Pexco	BL19AL1	BAG	\$ 88.000	5.0%				#REF! CALL FOR PRICE - EFFECTIVE 6/1/2021 DUE TO SUPPLY CHAIN ISSUES WE NEED TO EXCLUDE THIS PRODUCT LINE FROM ALL BIDS
#REF!	Baseball & Softball	114	10	Bottom Lock Privacy Decorative Slats for Chainlink Fencing - 2" mesh, *10'L, 24 lbs., BL24AL1 Standard colors: white, green, brown, black, beige, gray, redwood, royal blue, or light blue (1-599 Bags)	Pexco	BL24AL1	BAG	\$ 109.000	5.0%				#REF! CALL FOR PRICE - EFFECTIVE 6/1/2021 DUE TO SUPPLY CHAIN ISSUES WE NEED TO EXCLUDE THIS PRODUCT LINE FROM ALL BIDS
#REF!	Baseball & Softball	114	10	Bottom Lock Privacy Decorative Slats for Chainlink Fencing - 2" mesh, 82 slats, *12'L, 29 lbs., BL29AL1 Standard colors: white, green, brown, black, beige, gray, redwood, royal blue, or light blue (1-599 Bags)	Pexco	BL29AL1	BAG	\$ 131.000	5.0%				#REF! CALL FOR PRICE - EFFECTIVE 6/1/2021 DUE TO SUPPLY CHAIN ISSUES WE NEED TO EXCLUDE THIS PRODUCT LINE FROM ALL BIDS
#REF!	Baseball & Softball	114	10	Bottom Lock Privacy Decorative Slats for Chainlink Fencing - 2" mesh, 82 slats, *3'L, 7 lbs., #BL7AL2 Standard colors: white, green, brown, black, beige, gray, redwood, royal blue, or light blue (600-1199 Bags)	Pexco	BL7AL2	BAG	\$ 33.000	5.0%				#REF! CALL FOR PRICE - EFFECTIVE 6/1/2021 DUE TO SUPPLY CHAIN ISSUES WE NEED TO EXCLUDE THIS PRODUCT LINE FROM ALL BIDS
#REF!	Baseball & Softball	114	10	Bottom Lock Privacy Decorative Slats for Chainlink Fencing - 2" mesh, 82 slats, *3.5'L, 8 lbs., BL8AL2 Standard colors: white, green, brown, black, beige, gray, redwood, royal blue, or light blue (600-1199 Bags)	Pexco	BL8AL2	BAG	\$ 38.000	5.0%				#REF! CALL FOR PRICE - EFFECTIVE 6/1/2021 DUE TO SUPPLY CHAIN ISSUES WE NEED TO EXCLUDE THIS PRODUCT LINE FROM ALL BIDS
#REF!	Baseball & Softball	114	10	Bottom Lock Privacy Decorative Slats for Chainlink Fencing - 2" mesh, 82 slats, *4'L, 9 lbs., BL9AL2 Standard colors: white, green, brown, black, beige, gray, redwood, royal blue, or light blue (600-1199 Bags)	Pexco	BL9AL2	BAG	\$ 38.000	5.0%				#REF! CALL FOR PRICE - EFFECTIVE 6/1/2021 DUE TO SUPPLY CHAIN ISSUES WE NEED TO EXCLUDE THIS PRODUCT LINE FROM ALL BIDS
#REF!	Baseball & Softball	114	10	Bottom Lock Privacy Decorative Slats for Chainlink Fencing - 2" mesh, 82 slats, *5'L, 12 lbs., BL12AL2 Standard colors: white, green, brown, black, beige, gray, redwood, royal blue, or light blue (600-1199 Bags)	Pexco	BL12AL2	BAG	\$ 47.000	5.0%				#REF! CALL FOR PRICE - EFFECTIVE 6/1/2021 DUE TO SUPPLY CHAIN ISSUES WE NEED TO EXCLUDE THIS PRODUCT LINE FROM ALL BIDS
#REF!	Baseball & Softball	114	10	Bottom Lock Privacy Decorative Slats for Chainlink Fencing - 2" mesh, 82 slats, *6'L, 14 lbs., BL14AL2 Standard colors: white, green, brown, black, beige, gray, redwood, royal blue, or light blue (600-1199 Bags)	Pexco	BL14AL2	BAG	\$ 57.000	5.0%				#REF! CALL FOR PRICE - EFFECTIVE 6/1/2021 DUE TO SUPPLY CHAIN ISSUES WE NEED TO EXCLUDE THIS PRODUCT LINE FROM ALL BIDS
#REF!	Baseball & Softball	114	10	Bottom Lock Privacy Decorative Slats for Chainlink Fencing - 2" mesh, 82 slats, *7'L, 17 lbs., BL17AL2 Standard colors: white, green, brown, black, beige, gray, redwood, royal blue, or light blue (600-1199 Bags)	Pexco	BL17AL2	BAG	\$ 66.000	5.0%				#REF! CALL FOR PRICE - EFFECTIVE 6/1/2021 DUE TO SUPPLY CHAIN ISSUES WE NEED TO EXCLUDE THIS PRODUCT LINE FROM ALL BIDS
#REF!	Baseball & Softball	114	10	Bottom Lock Privacy Decorative Slats for Chainlink Fencing - 2" mesh, 82 slats, *8'L, 19 lbs., BL19AL2 Standard colors: white, green, brown, black, beige, gray, redwood, royal blue, or light blue (600-1199 Bags)	Pexco	BL19AL2	BAG	\$ 76.000	5.0%				#REF! CALL FOR PRICE - EFFECTIVE 6/1/2021 DUE TO SUPPLY CHAIN ISSUES WE NEED TO EXCLUDE THIS PRODUCT LINE FROM ALL BIDS
#REF!	Baseball & Softball	114	10	Bottom Lock Privacy Decorative Slats for Chainlink Fencing - 2" mesh, 82 slats, *10'L, 24 lbs., BL24AL2 Standard colors: white, green, brown, black, beige, gray, redwood, royal blue, or light blue (600-1199 Bags)	Pexco	BL24AL2	BAG	\$ 95.000	5.0%				#REF! CALL FOR PRICE - EFFECTIVE 6/1/2021 DUE TO SUPPLY CHAIN ISSUES WE NEED TO EXCLUDE THIS PRODUCT LINE FROM ALL BIDS
#REF!	Baseball & Softball	114	10	Bottom Lock Privacy Decorative Slats for Chainlink Fencing - 2" mesh, 82 slats, *12'L, 29 lbs., BL29AL2 Standard colors: white, green, brown, black, beige, gray, redwood, royal blue, or light blue (600-1199 Bags)	Pexco	BL29AL2	BAG	\$ 114.000	5.0%				#REF! CALL FOR PRICE - EFFECTIVE 6/1/2021 DUE TO SUPPLY CHAIN ISSUES WE NEED TO EXCLUDE THIS PRODUCT LINE FROM ALL BIDS
#REF!	Baseball & Softball	114	10	Bottom Lock Privacy Decorative Slats for Chainlink Fencing - 2-1/4" mesh, 78 slats, *3'L, 7 lbs., #BL7BL1 Standard colors: white, green, brown, black, beige, gray, redwood, royal blue, or light blue (1-599 Bags)	Pexco	BL7BL1	BAG	\$ 39.000	5.0%				#REF! CALL FOR PRICE - EFFECTIVE 6/1/2021 DUE TO SUPPLY CHAIN ISSUES WE NEED TO EXCLUDE THIS PRODUCT LINE FROM ALL BIDS
#REF!	Baseball & Softball	114	10	Bottom Lock Privacy Decorative Slats for Chainlink Fencing - 2-1/4" mesh, 78 slats, *3.5'L, 8 lbs., BL8BL1 Standard colors: white, green, brown, black, beige, gray, redwood, royal blue, or light blue (1-599 Bags)	Pexco	BL8BL1	BAG	\$ 44.000	5.0%				#REF! CALL FOR PRICE - EFFECTIVE 6/1/2021 DUE TO SUPPLY CHAIN ISSUES WE NEED TO EXCLUDE THIS PRODUCT LINE FROM ALL BIDS
#REF!	Baseball & Softball	114	10	Bottom Lock Privacy Decorative Slats for Chainlink Fencing - 2-1/4" mesh, 78 slats, *4'L, 9 lbs., BL9BL1 Standard colors: white, green, brown, black, beige, gray, redwood, royal blue, or light blue (1-599 Bags)	Pexco	BL9BL1	BAG	\$ 44.000	5.0%				#REF! CALL FOR PRICE - EFFECTIVE 6/1/2021 DUE TO SUPPLY CHAIN ISSUES WE NEED TO EXCLUDE THIS PRODUCT LINE FROM ALL BIDS
#REF!	Baseball & Softball	114	10	Bottom Lock Privacy Decorative Slats for Chainlink Fencing - 2-1/4" mesh, 78 slats, *5'L, 12 lbs., BL12BL1 Standard colors: white, green, brown, black, beige, gray, redwood, royal blue, or light blue (1-599 Bags)	Pexco	BL12BL1	BAG	\$ 55.000	5.0%				#REF! CALL FOR PRICE - EFFECTIVE 6/1/2021 DUE TO SUPPLY CHAIN ISSUES WE NEED TO EXCLUDE THIS PRODUCT LINE FROM ALL BIDS
#REF!	Baseball & Softball	114	10	Bottom Lock Privacy Decorative Slats for Chainlink Fencing - 2-1/4" mesh, 78 slats, *6'L, 14 lbs., BL14BL1 Standard colors: white, green, brown, black, beige, gray, redwood, royal blue, or light blue (1-599 Bags)	Pexco	BL14BL1	BAG	\$ 66.000	5.0%				#REF! CALL FOR PRICE - EFFECTIVE 6/1/2021 DUE TO SUPPLY CHAIN ISSUES WE NEED TO EXCLUDE THIS PRODUCT LINE FROM ALL BIDS
#REF!	Baseball & Softball	114	10	Bottom Lock Privacy Decorative Slats for Chainlink Fencing - 2-1/4" mesh, 78 slats, *7'L, 17 lbs., BL17BL1 Standard colors: white, green, brown, black, beige, gray, redwood, royal blue, or light blue (1-599 Bags)	Pexco	BL17BL1	BAG	\$ 77.000	5.0%				#REF! CALL FOR PRICE - EFFECTIVE 6/1/2021 DUE TO SUPPLY CHAIN ISSUES WE NEED TO EXCLUDE THIS PRODUCT LINE FROM ALL BIDS
#REF!	Baseball & Softball	114	10	Bottom Lock Privacy Decorative Slats for Chainlink Fencing - 2-1/4" mesh, 78 slats, *8'L, 19 lbs., BL19BL1 Standard colors: white, green, brown, black, beige, gray, redwood, royal blue, or light blue (1-599 Bags)	Pexco	BL19BL1	BAG	\$ 88.000	5.0%				#REF! CALL FOR PRICE - EFFECTIVE 6/1/2021 DUE TO SUPPLY CHAIN ISSUES WE NEED TO EXCLUDE THIS PRODUCT LINE FROM ALL BIDS
#REF!	Baseball & Softball	114	10	Bottom Lock Privacy Decorative Slats for Chainlink Fencing - 2-1/4" mesh, 78 slats, *10'L, 24 lbs., BL24BL1 Standard colors: white, green, brown, black, beige, gray, redwood, royal blue, or light blue (1-599 Bags)	Pexco	BL24BL1	BAG	\$ 109.000	5.0%				#REF! CALL FOR PRICE - EFFECTIVE 6/1/2021 DUE TO SUPPLY CHAIN ISSUES WE NEED TO EXCLUDE THIS PRODUCT LINE FROM ALL BIDS
#REF!	Baseball & Softball	114	10	Bottom Lock Privacy Decorative Slats for Chainlink Fencing - 2-1/4" mesh, 78 slats, *12'L, 29 lbs., BL29BL1 Standard colors: white, green, brown, black, beige, gray, redwood, royal blue, or light blue (1-599 Bags)	Pexco	BL29BL1	BAG	\$ 131.000	5.0%				#REF! CALL FOR PRICE - EFFECTIVE 6/1/2021 DUE TO SUPPLY CHAIN ISSUES WE NEED TO EXCLUDE THIS PRODUCT LINE FROM ALL BIDS
#REF!	Baseball & Softball	114	10	Bottom Lock Privacy Decorative Slats for Chainlink Fencing - 2-1/4" mesh, 78 slats, *3'L, 7 lbs., #BL7BL2 Standard colors: white, green, brown, black, beige, gray, redwood, royal blue, or light blue (600-1199 Bags)	Pexco	BL7BL2	BAG	\$ 33.000	5.0%				#REF! CALL FOR PRICE - EFFECTIVE 6/1/2021 DUE TO SUPPLY CHAIN ISSUES WE NEED TO EXCLUDE THIS PRODUCT LINE FROM ALL BIDS
#REF!	Baseball & Softball	114	10	Bottom Lock Privacy Decorative Slats for Chainlink Fencing - 2-1/4" mesh, 78 slats, *3.5'L, 8 lbs., BL8BL2 Standard colors: white, green, brown, black, beige, gray, redwood, royal blue, or light blue (600-1199 Bags)	Pexco	BL8BL2	BAG	\$ 38.000	5.0%				#REF! CALL FOR PRICE - EFFECTIVE 6/1/2021 DUE TO SUPPLY CHAIN ISSUES WE NEED TO EXCLUDE THIS PRODUCT LINE FROM ALL BIDS

Bidding Company Name:				Partac Peat Corporation	Catalog Name:		114 - Fence Guards, Rail Padding & Fence Slats					No.	
No.	Product Category	Beam Clay Catalog Section #	Page#	Product Description	Manufacturer	Vendor SKU	Unit of Measure	Catalog List Price	Bid Discount Percentage	Discount Amt.	Net Effective Bid Price	Comments	No.
#REF!	Baseball & Softball	114	10	Bottom Lock Privacy Decorative Slats for Chainlink Fencing - 2-1/4" mesh, 78 slats, *4'L, 9 lbs., BL9BL2 Standard colors: white, green, brown, black, beige, gray, redwood, royal blue, or light blue (600-1199 Bags)	Pexco	BL9BL2	BAG	\$ 38.000	5.0%				#REF! CALL FOR PRICE - EFFECTIVE 6/1/2021 DUE TO SUPPLY CHAIN ISSUES WE NEED TO EXCLUDE THIS PRODUCT LINE FROM ALL BIDS
#REF!	Baseball & Softball	114	10	Bottom Lock Privacy Decorative Slats for Chainlink Fencing - 2-1/4" mesh, 78 slats, *5'L, 12 lbs., BL12BL2 Standard colors: white, green, brown, black, beige, gray, redwood, royal blue, or light blue (600-1199 Bags)	Pexco	BL12BL2	BAG	\$ 47.000	5.0%				#REF! CALL FOR PRICE - EFFECTIVE 6/1/2021 DUE TO SUPPLY CHAIN ISSUES WE NEED TO EXCLUDE THIS PRODUCT LINE FROM ALL BIDS
#REF!	Baseball & Softball	114	10	Bottom Lock Privacy Decorative Slats for Chainlink Fencing - 2-1/4" mesh, 78 slats, *6'L, 14 lbs., BL14BL2 Standard colors: white, green, brown, black, beige, gray, redwood, royal blue, or light blue (600-1199 Bags)	Pexco	BL14BL2	BAG	\$ 57.000	5.0%				#REF! CALL FOR PRICE - EFFECTIVE 6/1/2021 DUE TO SUPPLY CHAIN ISSUES WE NEED TO EXCLUDE THIS PRODUCT LINE FROM ALL BIDS
#REF!	Baseball & Softball	114	10	Bottom Lock Privacy Decorative Slats for Chainlink Fencing - 2-1/4" mesh, 78 slats, *7'L, 17 lbs., BL17BL2 Standard colors: white, green, brown, black, beige, gray, redwood, royal blue, or light blue (600-1199 Bags)	Pexco	BL17BL2	BAG	\$ 66.000	5.0%				#REF! CALL FOR PRICE - EFFECTIVE 6/1/2021 DUE TO SUPPLY CHAIN ISSUES WE NEED TO EXCLUDE THIS PRODUCT LINE FROM ALL BIDS
#REF!	Baseball & Softball	114	10	Bottom Lock Privacy Decorative Slats for Chainlink Fencing - 2-1/4" mesh, 78 slats, *8'L, 19 lbs., BL19BL2 Standard colors: white, green, brown, black, beige, gray, redwood, royal blue, or light blue (600-1199 Bags)	Pexco	BL19BL2	BAG	\$ 76.000	5.0%				#REF! CALL FOR PRICE - EFFECTIVE 6/1/2021 DUE TO SUPPLY CHAIN ISSUES WE NEED TO EXCLUDE THIS PRODUCT LINE FROM ALL BIDS
#REF!	Baseball & Softball	114	10	Bottom Lock Privacy Decorative Slats for Chainlink Fencing - 2-1/4" mesh, 78 slats, *10'L, 24 lbs., BL24BL2 Standard colors: white, green, brown, black, beige, gray, redwood, royal blue, or light blue (600-1199 Bags)	Pexco	BL24BL2	BAG	\$ 95.000	5.0%				#REF! CALL FOR PRICE - EFFECTIVE 6/1/2021 DUE TO SUPPLY CHAIN ISSUES WE NEED TO EXCLUDE THIS PRODUCT LINE FROM ALL BIDS
#REF!	Baseball & Softball	114	10	Bottom Lock Privacy Decorative Slats for Chainlink Fencing - 2-1/4" mesh, 78 slats, *12'L, 29 lbs., BL29BL2 Standard colors: white, green, brown, black, beige, gray, redwood, royal blue, or light blue (600-1199 Bags)	Pexco	BL29BL2	BAG	\$ 114.000	5.0%				#REF! CALL FOR PRICE - EFFECTIVE 6/1/2021 DUE TO SUPPLY CHAIN ISSUES WE NEED TO EXCLUDE THIS PRODUCT LINE FROM ALL BIDS
#REF!	Baseball & Softball	114	10	Bottom Lock Privacy Decorative Slats for Chainlink Fencing - 1-3/4" mesh, 100 slats, *3'L, 7 lbs., #BL7CL1 Standard colors: white, green, brown, black, beige, gray, redwood, royal blue, or light blue (1-599 Bags)	Pexco	BL7CL1	BAG	\$ 48.750	5.0%				#REF! CALL FOR PRICE - EFFECTIVE 6/1/2021 DUE TO SUPPLY CHAIN ISSUES WE NEED TO EXCLUDE THIS PRODUCT LINE FROM ALL BIDS
#REF!	Baseball & Softball	114	10	Bottom Lock Privacy Decorative Slats for Chainlink Fencing - 1-3/4" mesh, 100 slats, *3.5'L, 8 lbs., BL8CL1 Standard colors: white, green, brown, black, beige, gray, redwood, royal blue, or light blue (1-599 Bags)	Pexco	BL8CL1	BAG	\$ 55.000	5.0%				#REF! CALL FOR PRICE - EFFECTIVE 6/1/2021 DUE TO SUPPLY CHAIN ISSUES WE NEED TO EXCLUDE THIS PRODUCT LINE FROM ALL BIDS
#REF!	Baseball & Softball	114	10	Bottom Lock Privacy Decorative Slats for Chainlink Fencing - 1-3/4" mesh, 100 slats, *4'L, 9 lbs., BL9CL1 Standard colors: white, green, brown, black, beige, gray, redwood, royal blue, or light blue (1-599 Bags)	Pexco	BL9CL1	BAG	\$ 55.000	5.0%				#REF! CALL FOR PRICE - EFFECTIVE 6/1/2021 DUE TO SUPPLY CHAIN ISSUES WE NEED TO EXCLUDE THIS PRODUCT LINE FROM ALL BIDS
#REF!	Baseball & Softball	114	10	Bottom Lock Privacy Decorative Slats for Chainlink Fencing - 1-3/4" mesh, 100 slats, *5'L, 12 lbs., BL12CL1 Standard colors: white, green, brown, black, beige, gray, redwood, royal blue, or light blue (1-599 Bags)	Pexco	BL12CL1	BAG	\$ 68.750	5.0%				#REF! CALL FOR PRICE - EFFECTIVE 6/1/2021 DUE TO SUPPLY CHAIN ISSUES WE NEED TO EXCLUDE THIS PRODUCT LINE FROM ALL BIDS
#REF!	Baseball & Softball	114	10	Bottom Lock Privacy Decorative Slats for Chainlink Fencing - 1-3/4" mesh, 100 slats, *6'L, 14 lbs., BL14CL1 Standard colors: white, green, brown, black, beige, gray, redwood, royal blue, or light blue (1-599 Bags)	Pexco	BL14CL1	BAG	\$ 82.500	5.0%				#REF! CALL FOR PRICE - EFFECTIVE 6/1/2021 DUE TO SUPPLY CHAIN ISSUES WE NEED TO EXCLUDE THIS PRODUCT LINE FROM ALL BIDS
#REF!	Baseball & Softball	114	10	Bottom Lock Privacy Decorative Slats for Chainlink Fencing - 1-3/4" mesh, 100 slats, *7'L, 17 lbs., BL17CL1 Standard colors: white, green, brown, black, beige, gray, redwood, royal blue, or light blue (1-599 Bags)	Pexco	BL17CL1	BAG	\$ 96.250	5.0%				#REF! CALL FOR PRICE - EFFECTIVE 6/1/2021 DUE TO SUPPLY CHAIN ISSUES WE NEED TO EXCLUDE THIS PRODUCT LINE FROM ALL BIDS
#REF!	Baseball & Softball	114	10	Bottom Lock Privacy Decorative Slats for Chainlink Fencing - 1-3/4" mesh, 100 slats, *8'L, 19 lbs., BL19CL1 Standard colors: white, green, brown, black, beige, gray, redwood, royal blue, or light blue (1-599 Bags)	Pexco	BL19CL1	BAG	\$ 110.000	5.0%				#REF! CALL FOR PRICE - EFFECTIVE 6/1/2021 DUE TO SUPPLY CHAIN ISSUES WE NEED TO EXCLUDE THIS PRODUCT LINE FROM ALL BIDS
#REF!	Baseball & Softball	114	10	Bottom Lock Privacy Decorative Slats for Chainlink Fencing - 1-3/4" mesh, 100 slats, *10'L, 24 lbs., BL24CL1 Standard colors: white, green, brown, black, beige, gray, redwood, royal blue, or light blue (1-599 Bags)	Pexco	BL24CL1	BAG	\$ 136.250	5.0%				#REF! CALL FOR PRICE - EFFECTIVE 6/1/2021 DUE TO SUPPLY CHAIN ISSUES WE NEED TO EXCLUDE THIS PRODUCT LINE FROM ALL BIDS
#REF!	Baseball & Softball	114	10	Bottom Lock Privacy Decorative Slats for Chainlink Fencing - 1-3/4" mesh, 100 slats, *12'L, 29 lbs., BL29CL1 Standard colors: white, green, brown, black, beige, gray, redwood, royal blue, or light blue (1-599 Bags)	Pexco	BL29CL1	BAG	\$ 163.750	5.0%				#REF! CALL FOR PRICE - EFFECTIVE 6/1/2021 DUE TO SUPPLY CHAIN ISSUES WE NEED TO EXCLUDE THIS PRODUCT LINE FROM ALL BIDS
#REF!	Baseball & Softball	114	10	Bottom Lock Privacy Decorative Slats for Chainlink Fencing - 1-3/4" mesh, 100 slats, *3'L, 7 lbs., #BL7CL2 Standard colors: white, green, brown, black, beige, gray, redwood, royal blue, or light blue (600 - 1199 Bags)	Pexco	BL7CL2	BAG	\$ 41.250	5.0%				#REF! CALL FOR PRICE - EFFECTIVE 6/1/2021 DUE TO SUPPLY CHAIN ISSUES WE NEED TO EXCLUDE THIS PRODUCT LINE FROM ALL BIDS
#REF!	Baseball & Softball	114	10	Bottom Lock Privacy Decorative Slats for Chainlink Fencing - 1-3/4" mesh, 100 slats, *3.5'L, 8 lbs., BL8CL2 Standard colors: white, green, brown, black, beige, gray, redwood, royal blue, or light blue (600 - 1199 Bags)	Pexco	BL8CL2	BAG	\$ 47.500	5.0%				#REF! CALL FOR PRICE - EFFECTIVE 6/1/2021 DUE TO SUPPLY CHAIN ISSUES WE NEED TO EXCLUDE THIS PRODUCT LINE FROM ALL BIDS
#REF!	Baseball & Softball	114	10	Bottom Lock Privacy Decorative Slats for Chainlink Fencing - 1-3/4" mesh, 100 slats, *4'L, 9 lbs., BL9CL2 Standard colors: white, green, brown, black, beige, gray, redwood, royal blue, or light blue (600 - 1199 Bags)	Pexco	BL9CL2	BAG	\$ 47.500	5.0%				#REF! CALL FOR PRICE - EFFECTIVE 6/1/2021 DUE TO SUPPLY CHAIN ISSUES WE NEED TO EXCLUDE THIS PRODUCT LINE FROM ALL BIDS
#REF!	Baseball & Softball	114	10	Bottom Lock Privacy Decorative Slats for Chainlink Fencing - 1-3/4" mesh, 100 slats, *5'L, 12 lbs., BL12CL2 Standard colors: white, green, brown, black, beige, gray, redwood, royal blue, or light blue (600 - 1199 Bags)	Pexco	BL12CL2	BAG	\$ 58.750	5.0%				#REF! CALL FOR PRICE - EFFECTIVE 6/1/2021 DUE TO SUPPLY CHAIN ISSUES WE NEED TO EXCLUDE THIS PRODUCT LINE FROM ALL BIDS
#REF!	Baseball & Softball	114	10	Bottom Lock Privacy Decorative Slats for Chainlink Fencing - 1-3/4" mesh, 100 slats, *6'L, 14 lbs., BL14CL2 Standard colors: white, green, brown, black, beige, gray, redwood, royal blue, or light blue (600 - 1199 Bags)	Pexco	BL14CL2	BAG	\$ 71.250	5.0%				#REF! CALL FOR PRICE - EFFECTIVE 6/1/2021 DUE TO SUPPLY CHAIN ISSUES WE NEED TO EXCLUDE THIS PRODUCT LINE FROM ALL BIDS
#REF!	Baseball & Softball	114	10	Bottom Lock Privacy Decorative Slats for Chainlink Fencing - 1-3/4" mesh, 100 slats, *7'L, 17 lbs., BL17CL2 Standard colors: white, green, brown, black, beige, gray, redwood, royal blue, or light blue (600 - 1199 Bags)	Pexco	BL17CL2	BAG	\$ 82.500	5.0%				#REF! CALL FOR PRICE - EFFECTIVE 6/1/2021 DUE TO SUPPLY CHAIN ISSUES WE NEED TO EXCLUDE THIS PRODUCT LINE FROM ALL BIDS
#REF!	Baseball & Softball	114	10	Bottom Lock Privacy Decorative Slats for Chainlink Fencing - 1-3/4" mesh, 100 slats, *8'L, 19 lbs., BL19CL2 Standard colors: white, green, brown, black, beige, gray, redwood, royal blue, or light blue (600 - 1199 Bags)	Pexco	BL19CL2	BAG	\$ 95.000	5.0%				#REF! CALL FOR PRICE - EFFECTIVE 6/1/2021 DUE TO SUPPLY CHAIN ISSUES WE NEED TO EXCLUDE THIS PRODUCT LINE FROM ALL BIDS

Bidding Company Name:				Partac Peat Corporation	Catalog Name:		114 - Fence Guards, Rail Padding & Fence Slats					No.	
No.	Product Category	Beam Clay Catalog Section #	Page#	Product Description	Manufacturer	Vendor SKU	Unit of Measure	Catalog List Price	Bid Discount Percentage	Discount Amt.	Net Effective Bid Price	Comments	No.
#REF!	Baseball & Softball	114	10	Bottom Lock Privacy Decorative Slats for Chainlink Fencing - 1-3/4" mesh, 100 slats, *10'L, 24 lbs., BL24CL2 Standard colors: white, green, brown, black, beige, gray, redwood, royal blue, or light blue (600 - 1199 Bags)	Pexco	BL24CL1	BAG	\$ 118.750	5.0%				#REF! CALL FOR PRICE - EFFECTIVE 6/1/2021 DUE TO SUPPLY CHAIN ISSUES WE NEED TO EXCLUDE THIS PRODUCT LINE FROM ALL BIDS
#REF!	Baseball & Softball	114	10	Bottom Lock Privacy Decorative Slats for Chainlink Fencing - 1-3/4" mesh, 100 slats, *12'L, 29 lbs., BL29CL2 Standard colors: white, green, brown, black, beige, gray, redwood, royal blue, or light blue (600 - 1199 Bags)	Pexco	BL29CL1	BAG	\$ 142.500	5.0%				#REF! CALL FOR PRICE - EFFECTIVE 6/1/2021 DUE TO SUPPLY CHAIN ISSUES WE NEED TO EXCLUDE THIS PRODUCT LINE FROM ALL BIDS
#REF!	Baseball & Softball	114	10	Extra Channel EC	Pexco	EC	LF	\$ 0.320	5.0%				#REF! CALL FOR PRICE - EFFECTIVE 6/1/2021 DUE TO SUPPLY CHAIN ISSUES WE NEED TO EXCLUDE THIS PRODUCT LINE FROM ALL BIDS
#REF!	Baseball & Softball	114	10	Top Lock Privacy Decorative Slats for Chainlink Fencing - 2" mesh, 82 slats, *3'L, 7 lbs., #TL7AL1 Standard colors: white, green, brown, black, beige, gray, redwood, royal blue, or light blue (1-599 Bags)	Pexco	TL7AL1	BAG	\$ 39.000	5.0%				#REF! CALL FOR PRICE - EFFECTIVE 6/1/2021 DUE TO SUPPLY CHAIN ISSUES WE NEED TO EXCLUDE THIS PRODUCT LINE FROM ALL BIDS
#REF!	Baseball & Softball	114	10	Top Lock Privacy Decorative Slats for Chainlink Fencing - 2" mesh, 82 slats, *3.5'L, 8 lbs., TL8AL1 Standard colors: white, green, brown, black, beige, gray, redwood, royal blue, or light blue (1-599 Bags)	Pexco	TL8AL1	BAG	\$ 44.000	5.0%				#REF! CALL FOR PRICE - EFFECTIVE 6/1/2021 DUE TO SUPPLY CHAIN ISSUES WE NEED TO EXCLUDE THIS PRODUCT LINE FROM ALL BIDS
#REF!	Baseball & Softball	114	10	Top Lock Privacy Decorative Slats for Chainlink Fencing - 2" mesh, 82 slats, *4'L, 9 lbs., TL9AL1 Standard colors: white, green, brown, black, beige, gray, redwood, royal blue, or light blue (1-599 Bags)	Pexco	TL9AL1	BAG	\$ 44.000	5.0%				#REF! CALL FOR PRICE - EFFECTIVE 6/1/2021 DUE TO SUPPLY CHAIN ISSUES WE NEED TO EXCLUDE THIS PRODUCT LINE FROM ALL BIDS
#REF!	Baseball & Softball	114	10	Bottom Lock Privacy Decorative Slats for Chainlink Fencing - 2" mesh, 82 slats, *5'L, 12 lbs., TL12AL1 Standard colors: white, green, brown, black, beige, gray, redwood, royal blue, or light blue (1-599 Bags)	Pexco	TL12AL1	BAG	\$ 55.000	5.0%				#REF! CALL FOR PRICE - EFFECTIVE 6/1/2021 DUE TO SUPPLY CHAIN ISSUES WE NEED TO EXCLUDE THIS PRODUCT LINE FROM ALL BIDS
#REF!	Baseball & Softball	114	10	Top Lock Privacy Decorative Slats for Chainlink Fencing - 2" mesh, 82 slats, *6'L, 14 lbs., TL14AL1 Standard colors: white, green, brown, black, beige, gray, redwood, royal blue, or light blue (1-599 Bags)	Pexco	TL14AL1	BAG	\$ 66.000	5.0%				#REF! CALL FOR PRICE - EFFECTIVE 6/1/2021 DUE TO SUPPLY CHAIN ISSUES WE NEED TO EXCLUDE THIS PRODUCT LINE FROM ALL BIDS
#REF!	Baseball & Softball	114	10	Top Lock Privacy Decorative Slats for Chainlink Fencing - 2" mesh, 82 slats, *7'L, 17 lbs., TL17AL1 Standard colors: white, green, brown, black, beige, gray, redwood, royal blue, or light blue (1-599 Bags)	Pexco	TL17AL1	BAG	\$ 77.000	5.0%				#REF! CALL FOR PRICE - EFFECTIVE 6/1/2021 DUE TO SUPPLY CHAIN ISSUES WE NEED TO EXCLUDE THIS PRODUCT LINE FROM ALL BIDS
#REF!	Baseball & Softball	114	10	Top Lock Privacy Decorative Slats for Chainlink Fencing - 2" mesh, 82 slats, *8'L, 19 lbs., TL19AL1 Standard colors: white, green, brown, black, beige, gray, redwood, royal blue, or light blue (1-599 Bags)	Pexco	TL19AL1	BAG	\$ 88.000	5.0%				#REF! CALL FOR PRICE - EFFECTIVE 6/1/2021 DUE TO SUPPLY CHAIN ISSUES WE NEED TO EXCLUDE THIS PRODUCT LINE FROM ALL BIDS
#REF!	Baseball & Softball	114	10	Top Lock Privacy Decorative Slats for Chainlink Fencing - 2" mesh, 82 slats, *10'L, 24 lbs., TL24AL1 Standard colors: white, green, brown, black, beige, gray, redwood, royal blue, or light blue (1-599 Bags)	Pexco	TL24AL1	BAG	\$ 109.000	5.0%				#REF! CALL FOR PRICE - EFFECTIVE 6/1/2021 DUE TO SUPPLY CHAIN ISSUES WE NEED TO EXCLUDE THIS PRODUCT LINE FROM ALL BIDS
#REF!	Baseball & Softball	114	10	Top Lock Privacy Decorative Slats for Chainlink Fencing - 2" mesh, 82 slats, *12'L, 29 lbs., TL29AL1 Standard colors: white, green, brown, black, beige, gray, redwood, royal blue, or light blue (1-599 Bags)	Pexco	TL29AL1	BAG	\$ 131.000	5.0%				#REF! CALL FOR PRICE - EFFECTIVE 6/1/2021 DUE TO SUPPLY CHAIN ISSUES WE NEED TO EXCLUDE THIS PRODUCT LINE FROM ALL BIDS
#REF!	Baseball & Softball	114	10	Top Lock Privacy Decorative Slats for Chainlink Fencing - 2" mesh, 82 slats, *3'L, 7 lbs., #TL7AL2 Standard colors: white, green, brown, black, beige, gray, redwood, royal blue, or light blue (600-1199 Bags)	Pexco	TL7AL2	BAG	\$ 33.000	5.0%				#REF! CALL FOR PRICE - EFFECTIVE 6/1/2021 DUE TO SUPPLY CHAIN ISSUES WE NEED TO EXCLUDE THIS PRODUCT LINE FROM ALL BIDS
#REF!	Baseball & Softball	114	10	Top Lock Privacy Decorative Slats for Chainlink Fencing - 2" mesh, 82 slats, *3.5'L, 8 lbs., TL8AL2 Standard colors: white, green, brown, black, beige, gray, redwood, royal blue, or light blue (600-1199 Bags)	Pexco	TL8AL2	BAG	\$ 38.000	5.0%				#REF! CALL FOR PRICE - EFFECTIVE 6/1/2021 DUE TO SUPPLY CHAIN ISSUES WE NEED TO EXCLUDE THIS PRODUCT LINE FROM ALL BIDS
#REF!	Baseball & Softball	114	10	Top Lock Privacy Decorative Slats for Chainlink Fencing - 2" mesh, 82 slats, *4'L, 9 lbs., TL9AL2 Standard colors: white, green, brown, black, beige, gray, redwood, royal blue, or light blue (600-1199 Bags)	Pexco	TL9AL2	BAG	\$ 38.000	5.0%				#REF! CALL FOR PRICE - EFFECTIVE 6/1/2021 DUE TO SUPPLY CHAIN ISSUES WE NEED TO EXCLUDE THIS PRODUCT LINE FROM ALL BIDS
#REF!	Baseball & Softball	114	10	Top Lock Privacy Decorative Slats for Chainlink Fencing - 2" mesh, 82 slats, *5'L, 12 lbs., TL12AL2 Standard colors: white, green, brown, black, beige, gray, redwood, royal blue, or light blue (600-1199 Bags)	Pexco	TL12AL2	BAG	\$ 47.000	5.0%				#REF! CALL FOR PRICE - EFFECTIVE 6/1/2021 DUE TO SUPPLY CHAIN ISSUES WE NEED TO EXCLUDE THIS PRODUCT LINE FROM ALL BIDS
#REF!	Baseball & Softball	114	10	Top Lock Privacy Decorative Slats for Chainlink Fencing - 2" mesh, 82 slats, *6'L, 14 lbs., TL14AL2 Standard colors: white, green, brown, black, beige, gray, redwood, royal blue, or light blue (600-1199 Bags)	Pexco	TL14AL2	BAG	\$ 57.000	5.0%				#REF! CALL FOR PRICE - EFFECTIVE 6/1/2021 DUE TO SUPPLY CHAIN ISSUES WE NEED TO EXCLUDE THIS PRODUCT LINE FROM ALL BIDS
#REF!	Baseball & Softball	114	10	Top Lock Privacy Decorative Slats for Chainlink Fencing - 2" mesh, 82 slats, *7'L, 17 lbs., TL17AL2 Standard colors: white, green, brown, black, beige, gray, redwood, royal blue, or light blue (600-1199 Bags)	Pexco	TL17AL2	BAG	\$ 66.000	5.0%				#REF! CALL FOR PRICE - EFFECTIVE 6/1/2021 DUE TO SUPPLY CHAIN ISSUES WE NEED TO EXCLUDE THIS PRODUCT LINE FROM ALL BIDS
#REF!	Baseball & Softball	114	10	Top Lock Privacy Decorative Slats for Chainlink Fencing - 2" mesh, 82 slats, *8'L, 19 lbs., TL19AL2 Standard colors: white, green, brown, black, beige, gray, redwood, royal blue, or light blue (600-1199 Bags)	Pexco	TL19AL2	BAG	\$ 76.000	5.0%				#REF! CALL FOR PRICE - EFFECTIVE 6/1/2021 DUE TO SUPPLY CHAIN ISSUES WE NEED TO EXCLUDE THIS PRODUCT LINE FROM ALL BIDS
#REF!	Baseball & Softball	114	10	Top Lock Privacy Decorative Slats for Chainlink Fencing - 2" mesh, 82 slats, *10'L, 24 lbs., TL24AL2 Standard colors: white, green, brown, black, beige, gray, redwood, royal blue, or light blue (600-1199 Bags)	Pexco	TL24AL2	BAG	\$ 95.000	5.0%				#REF! CALL FOR PRICE - EFFECTIVE 6/1/2021 DUE TO SUPPLY CHAIN ISSUES WE NEED TO EXCLUDE THIS PRODUCT LINE FROM ALL BIDS
#REF!	Baseball & Softball	114	10	Top Lock Privacy Decorative Slats for Chainlink Fencing - 2" mesh, 82 slats, *12'L, 29 lbs., TL29AL2 Standard colors: white, green, brown, black, beige, gray, redwood, royal blue, or light blue (600-1199 Bags)	Pexco	TL29AL2	BAG	\$ 114.000	5.0%				#REF! CALL FOR PRICE - EFFECTIVE 6/1/2021 DUE TO SUPPLY CHAIN ISSUES WE NEED TO EXCLUDE THIS PRODUCT LINE FROM ALL BIDS
#REF!	Baseball & Softball	114	10	Top Lock Privacy Decorative Slats for Chainlink Fencing - 2-1/4" Mesh, 78 slats or 1 3/4" Mesh, *3'L, 7 lbs., #TL7BL1 Standard colors: white, green, brown, black, beige, gray, redwood, royal blue, or light blue (1-599 Bags)	Pexco	TL7BL1	BAG	\$ 48.750	5.0%				#REF! CALL FOR PRICE - EFFECTIVE 6/1/2021 DUE TO SUPPLY CHAIN ISSUES WE NEED TO EXCLUDE THIS PRODUCT LINE FROM ALL BIDS
#REF!	Baseball & Softball	114	10	Top Lock Privacy Decorative Slats for Chainlink Fencing - 2-1/4" Mesh, 78 slats or 1 3/4" Mesh, *3.5'L, 8 lbs., TL8BL1 Standard colors: white, green, brown, black, beige, gray, redwood, royal blue, or light blue (1-599 Bags)	Pexco	TL8BL1	BAG	\$ 55.000	5.0%				#REF! CALL FOR PRICE - EFFECTIVE 6/1/2021 DUE TO SUPPLY CHAIN ISSUES WE NEED TO EXCLUDE THIS PRODUCT LINE FROM ALL BIDS

Bidding Company Name:				Partac Peat Corporation	Catalog Name:		114 - Fence Guards, Rail Padding & Fence Slats					No.	
No.	Product Category	Beam Clay Catalog Section #	Page#	Product Description	Manufacturer	Vendor SKU	Unit of Measure	Catalog List Price	Bid Discount Percentage	Discount Amt.	Net Effective Bid Price	Comments	No.
#REF!	Baseball & Softball	114	10	Top Lock Privacy Decorative Slats for Chainlink Fencing - 2-1/4" Mesh, 78 slats or 1 3/4" Mesh *4'L, 9 lbs., TL9BL1 Standard colors: white, green, brown, black, beige, gray, redwood, royal blue, or light blue (1-599 Bags)	Pexco	TL9BL1	BAG	\$ 55.000	5.0%				#REF! CALL FOR PRICE - EFFECTIVE 6/1/2021 DUE TO SUPPLY CHAIN ISSUES WE NEED TO EXCLUDE THIS PRODUCT LINE FROM ALL BIDS
#REF!	Baseball & Softball	114	10	Top Lock Privacy Decorative Slats for Chainlink Fencing - 2-1/4" Mesh, 78 slats or 1 3/4" Mesh, *5'L, 12 lbs., TL12BL1 Standard colors: white, green, brown, black, beige, gray, redwood, royal blue, or light blue (1-599 Bags)	Pexco	TL12BL1	BAG	\$ 68.750	5.0%				#REF! CALL FOR PRICE - EFFECTIVE 6/1/2021 DUE TO SUPPLY CHAIN ISSUES WE NEED TO EXCLUDE THIS PRODUCT LINE FROM ALL BIDS
#REF!	Baseball & Softball	114	10	Top Lock Privacy Decorative Slats for Chainlink Fencing - 2-1/4" Mesh, 78 slats or 1 3/4" Mesh, *6'L, 14 lbs., TL14BL1 Standard colors: white, green, brown, black, beige, gray, redwood, royal blue, or light blue (1-599 Bags)	Pexco	TL14BL1	BAG	\$ 82.500	5.0%				#REF! CALL FOR PRICE - EFFECTIVE 6/1/2021 DUE TO SUPPLY CHAIN ISSUES WE NEED TO EXCLUDE THIS PRODUCT LINE FROM ALL BIDS
#REF!	Baseball & Softball	114	10	Top Lock Privacy Decorative Slats for Chainlink Fencing - 2-1/4" Mesh, 78 slats or 1 3/4" Mesh, *7'L, 17 lbs., TL17BL1 Standard colors: white, green, brown, black, beige, gray, redwood, royal blue, or light blue (1-599 Bags)	Pexco	TL17BL1	BAG	\$ 96.250	5.0%				#REF! CALL FOR PRICE - EFFECTIVE 6/1/2021 DUE TO SUPPLY CHAIN ISSUES WE NEED TO EXCLUDE THIS PRODUCT LINE FROM ALL BIDS
#REF!	Baseball & Softball	114	10	Top Lock Privacy Decorative Slats for Chainlink Fencing - 2-1/4" Mesh, 78 slats or 1 3/4" Mesh, *8'L, 19 lbs., TL19BL1 Standard colors: white, green, brown, black, beige, gray, redwood, royal blue, or light blue (1-599 Bags)	Pexco	TL19BL1	BAG	\$ 110.000	5.0%				#REF! CALL FOR PRICE - EFFECTIVE 6/1/2021 DUE TO SUPPLY CHAIN ISSUES WE NEED TO EXCLUDE THIS PRODUCT LINE FROM ALL BIDS
#REF!	Baseball & Softball	114	10	Top Lock Privacy Decorative Slats for Chainlink Fencing - 2-1/4" Mesh, 78 slats or 1 3/4" Mesh, *10'L, 24 lbs., TL24BL1 Standard colors: white, green, brown, black, beige, gray, redwood, royal blue, or light blue (1-599 Bags)	Pexco	TL24BL1	BAG	\$ 136.250	5.0%				#REF! CALL FOR PRICE - EFFECTIVE 6/1/2021 DUE TO SUPPLY CHAIN ISSUES WE NEED TO EXCLUDE THIS PRODUCT LINE FROM ALL BIDS
#REF!	Baseball & Softball	114	10	Top Lock Privacy Decorative Slats for Chainlink Fencing - 2-1/4" Mesh, 78 slats or 1 3/4" Mesh, *12'L, 29 lbs., TL29BL1 Standard colors: white, green, brown, black, beige, gray, redwood, royal blue, or light blue (1-599 Bags)	Pexco	TL29BL1	BAG	\$ 163.750	5.0%				#REF! CALL FOR PRICE - EFFECTIVE 6/1/2021 DUE TO SUPPLY CHAIN ISSUES WE NEED TO EXCLUDE THIS PRODUCT LINE FROM ALL BIDS
#REF!	Baseball & Softball	114	10	Top Lock Privacy Decorative Slats for Chainlink Fencing - 2-1/4" Mesh, 78 slats or 1 3/4" Mesh, *3'L, 7 lbs., #TL7BL2 Standard colors: white, green, brown, black, beige, gray, redwood, royal blue, or light blue (600-1199 Bags)	Pexco	TL7BL2	BAG	\$ 41.250	5.0%				#REF! CALL FOR PRICE - EFFECTIVE 6/1/2021 DUE TO SUPPLY CHAIN ISSUES WE NEED TO EXCLUDE THIS PRODUCT LINE FROM ALL BIDS
#REF!	Baseball & Softball	114	10	Top Lock Privacy Decorative Slats for Chainlink Fencing - 2-1/4" Mesh, 78 slats or 1 3/4" Mesh, *3.5'L, 8 lbs., TL8BL2 Standard colors: white, green, brown, black, beige, gray, redwood, royal blue, or light blue (600-1199 Bags)	Pexco	TL8BL2	BAG	\$ 47.500	5.0%				#REF! CALL FOR PRICE - EFFECTIVE 6/1/2021 DUE TO SUPPLY CHAIN ISSUES WE NEED TO EXCLUDE THIS PRODUCT LINE FROM ALL BIDS
#REF!	Baseball & Softball	114	10	Top Lock Privacy Decorative Slats for Chainlink Fencing - 2-1/4" Mesh, 78 slats or 1 3/4" Mesh, *4'L, 9 lbs., TL9BL2 Standard colors: white, green, brown, black, beige, gray, redwood, royal blue, or light blue (600-1199 Bags)	Pexco	TL9BL2	BAG	\$ 47.500	5.0%				#REF! CALL FOR PRICE - EFFECTIVE 6/1/2021 DUE TO SUPPLY CHAIN ISSUES WE NEED TO EXCLUDE THIS PRODUCT LINE FROM ALL BIDS
#REF!	Baseball & Softball	114	10	Top Lock Privacy Decorative Slats for Chainlink Fencing - 2-1/4" Mesh, 78 slats or 1 3/4" Mesh, *5'L, 12 lbs., TL12BL2 Standard colors: white, green, brown, black, beige, gray, redwood, royal blue, or light blue (600-1199 Bags)	Pexco	TL12BL2	BAG	\$ 58.750	5.0%				#REF! CALL FOR PRICE - EFFECTIVE 6/1/2021 DUE TO SUPPLY CHAIN ISSUES WE NEED TO EXCLUDE THIS PRODUCT LINE FROM ALL BIDS
#REF!	Baseball & Softball	114	10	Top Lock Privacy Decorative Slats for Chainlink Fencing - 2-1/4" Mesh, 78 slats or 1 3/4" Mesh, *6'L, 14 lbs., TL14BL2 Standard colors: white, green, brown, black, beige, gray, redwood, royal blue, or light blue (600-1199 Bags)	Pexco	TL14BL2	BAG	\$ 71.250	5.0%				#REF! CALL FOR PRICE - EFFECTIVE 6/1/2021 DUE TO SUPPLY CHAIN ISSUES WE NEED TO EXCLUDE THIS PRODUCT LINE FROM ALL BIDS
#REF!	Baseball & Softball	114	10	Top Lock Privacy Decorative Slats for Chainlink Fencing - 2-1/4" Mesh, 78 slats or 1 3/4" Mesh, *7'L, 17 lbs., TL17BL2 Standard colors: white, green, brown, black, beige, gray, redwood, royal blue, or light blue (600-1199 Bags)	Pexco	TL17BL2	BAG	\$ 82.500	5.0%				#REF! CALL FOR PRICE - EFFECTIVE 6/1/2021 DUE TO SUPPLY CHAIN ISSUES WE NEED TO EXCLUDE THIS PRODUCT LINE FROM ALL BIDS
#REF!	Baseball & Softball	114	10	Top Lock Privacy Decorative Slats for Chainlink Fencing - 2-1/4" Mesh, 78 slats or 1 3/4" Mesh, *8'L, 19 lbs., TL19BL2 Standard colors: white, green, brown, black, beige, gray, redwood, royal blue, or light blue (600-1199 Bags)	Pexco	TL19BL2	BAG	\$ 95.000	5.0%				#REF! CALL FOR PRICE - EFFECTIVE 6/1/2021 DUE TO SUPPLY CHAIN ISSUES WE NEED TO EXCLUDE THIS PRODUCT LINE FROM ALL BIDS
#REF!	Baseball & Softball	114	10	Top Lock Privacy Decorative Slats for Chainlink Fencing - 2-1/4" Mesh, 78 slats or 1 3/4" Mesh, *10'L, 24 lbs., TL24BL2 Standard colors: white, green, brown, black, beige, gray, redwood, royal blue, or light blue (600-1199 Bags)	Pexco	TL24BL2	BAG	\$ 118.750	5.0%				#REF! CALL FOR PRICE - EFFECTIVE 6/1/2021 DUE TO SUPPLY CHAIN ISSUES WE NEED TO EXCLUDE THIS PRODUCT LINE FROM ALL BIDS
#REF!	Baseball & Softball	114	10	Top Lock Privacy Decorative Slats for Chainlink Fencing - 2-1/4" Mesh, 78 slats or 1 3/4" Mesh, *12'L, 29 lbs., TL29BL2 Standard colors: white, green, brown, black, beige, gray, redwood, royal blue, or light blue (600-1199 Bags)	Pexco	TL29BL2	BAG	\$ 142.500	5.0%				#REF! CALL FOR PRICE - EFFECTIVE 6/1/2021 DUE TO SUPPLY CHAIN ISSUES WE NEED TO EXCLUDE THIS PRODUCT LINE FROM ALL BIDS
#REF!	Baseball & Softball	114	10	Top Lock Privacy Decorative Slats for Chainlink Fencing - 2-1/4" Mesh, 78 slats or 1 3/4" Mesh, *3'L, 7 lbs., #TL7CL1 Standard colors: white, green, brown, black, beige, gray, redwood, royal blue, or light blue (1-599 Bags)	Pexco	TL7CL1	BAG	\$ 48.750	5.0%				#REF! CALL FOR PRICE - EFFECTIVE 6/1/2021 DUE TO SUPPLY CHAIN ISSUES WE NEED TO EXCLUDE THIS PRODUCT LINE FROM ALL BIDS
#REF!	Baseball & Softball	114	10	Top Lock Privacy Decorative Slats for Chainlink Fencing - 2-1/4" Mesh, 78 slats or 1 3/4" Mesh, *3.5'L, 8 lbs., TL8CL1 Standard colors: white, green, brown, black, beige, gray, redwood, royal blue, or light blue (1-599 Bags)	Pexco	TL8CL1	BAG	\$ 55.000	5.0%				#REF! CALL FOR PRICE - EFFECTIVE 6/1/2021 DUE TO SUPPLY CHAIN ISSUES WE NEED TO EXCLUDE THIS PRODUCT LINE FROM ALL BIDS
#REF!	Baseball & Softball	114	10	Top Lock Privacy Decorative Slats for Chainlink Fencing - 2-1/4" Mesh, 78 slats or 1 3/4" Mesh *4'L, 9 lbs., TL9CL1 Standard colors: white, green, brown, black, beige, gray, redwood, royal blue, or light blue (1-599 Bags)	Pexco	TL9CL1	BAG	\$ 55.000	5.0%				#REF! CALL FOR PRICE - EFFECTIVE 6/1/2021 DUE TO SUPPLY CHAIN ISSUES WE NEED TO EXCLUDE THIS PRODUCT LINE FROM ALL BIDS
#REF!	Baseball & Softball	114	10	Top Lock Privacy Decorative Slats for Chainlink Fencing - 2-1/4" Mesh, 78 slats or 1 3/4" Mesh, *5'L, 12 lbs., TL12CL1 Standard colors: white, green, brown, black, beige, gray, redwood, royal blue, or light blue (1-599 Bags)	Pexco	TL12CL1	BAG	\$ 69.750	5.0%				#REF! CALL FOR PRICE - EFFECTIVE 6/1/2021 DUE TO SUPPLY CHAIN ISSUES WE NEED TO EXCLUDE THIS PRODUCT LINE FROM ALL BIDS
#REF!	Baseball & Softball	114	10	Top Lock Privacy Decorative Slats for Chainlink Fencing - 2-1/4" Mesh, 78 slats or 1 3/4" Mesh, *6'L, 14 lbs., TL14CL1 Standard colors: white, green, brown, black, beige, gray, redwood, royal blue, or light blue (1-599 Bags)	Pexco	TL14CL1	BAG	\$ 82.500	5.0%				#REF! CALL FOR PRICE - EFFECTIVE 6/1/2021 DUE TO SUPPLY CHAIN ISSUES WE NEED TO EXCLUDE THIS PRODUCT LINE FROM ALL BIDS
#REF!	Baseball & Softball	114	10	Top Lock Privacy Decorative Slats for Chainlink Fencing - 2-1/4" Mesh, 78 slats or 1 3/4" Mesh, *7'L, 17 lbs., TL17CL1 Standard colors: white, green, brown, black, beige, gray, redwood, royal blue, or light blue (1-599 Bags)	Pexco	TL17CL1	BAG	\$ 96.250	5.0%				#REF! CALL FOR PRICE - EFFECTIVE 6/1/2021 DUE TO SUPPLY CHAIN ISSUES WE NEED TO EXCLUDE THIS PRODUCT LINE FROM ALL BIDS
#REF!	Baseball & Softball	114	10	Top Lock Privacy Decorative Slats for Chainlink Fencing - 2-1/4" Mesh, 78 slats or 1 3/4" Mesh, *8'L, 19 lbs., TL19CL1 Standard colors: white, green, brown, black, beige, gray, redwood, royal blue, or light blue (1-599 Bags)	Pexco	TL19CL1	BAG	\$ 110.000	5.0%				#REF! CALL FOR PRICE - EFFECTIVE 6/1/2021 DUE TO SUPPLY CHAIN ISSUES WE NEED TO EXCLUDE THIS PRODUCT LINE FROM ALL BIDS

Bidding Company Name:				Partac Peat Corporation	Catalog Name:		114 - Fence Guards, Rail Padding & Fence Slats					No.	
No.	Product Category	Beam Clay Catalog Section #	Page#	Product Description	Manufacturer	Vendor SKU	Unit of Measure	Catalog List Price	Bid Discount Percentage	Discount Amt.	Net Effective Bid Price	Comments	No.
#REF!	Baseball & Softball	114	10	Top Lock Privacy Decorative Slats for Chainlink Fencing - 2-1/4" Mesh, 78 slats or 1 3/4" Mesh, *10'L, 24 lbs., TL24CL1 Standard colors: white, green, brown, black, beige, gray, redwood, royal blue, or light blue (1-599 Bags)	Pexco	TL24CL1	BAG	\$ 136.250	5.0%				#REF! CALL FOR PRICE - EFFECTIVE 6/1/2021 DUE TO SUPPLY CHAIN ISSUES WE NEED TO EXCLUDE THIS PRODUCT LINE FROM ALL BIDS
#REF!	Baseball & Softball	114	10	Top Lock Privacy Decorative Slats for Chainlink Fencing - 2-1/4" Mesh, 78 slats or 1 3/4" Mesh, *12'L, 29 lbs., TL29CL1 Standard colors: white, green, brown, black, beige, gray, redwood, royal blue, or light blue (1-599 Bags)	Pexco	TL29CL1	BAG	\$ 163.750	5.0%				#REF! CALL FOR PRICE - EFFECTIVE 6/1/2021 DUE TO SUPPLY CHAIN ISSUES WE NEED TO EXCLUDE THIS PRODUCT LINE FROM ALL BIDS
#REF!	Baseball & Softball	114	10	Top Lock Privacy Decorative Slats for Chainlink Fencing - 2-1/4" Mesh, 78 slats or 1 3/4" Mesh, *3'L, 7 lbs., #TL7CL2 Standard colors: white, green, brown, black, beige, gray, redwood, royal blue, or light blue (600-1199 Bags)	Pexco	TL7CL2	BAG	\$ 44.250	5.0%				#REF! CALL FOR PRICE - EFFECTIVE 6/1/2021 DUE TO SUPPLY CHAIN ISSUES WE NEED TO EXCLUDE THIS PRODUCT LINE FROM ALL BIDS
#REF!	Baseball & Softball	114	10	Top Lock Privacy Decorative Slats for Chainlink Fencing - 2-1/4" Mesh, 78 slats or 1 3/4" Mesh, *3.5'L, 8 lbs., TL8CL2 Standard colors: white, green, brown, black, beige, gray, redwood, royal blue, or light blue (600-1199 Bags)	Pexco	TL8CL2	BAG	\$ 47.500	5.0%				#REF! CALL FOR PRICE - EFFECTIVE 6/1/2021 DUE TO SUPPLY CHAIN ISSUES WE NEED TO EXCLUDE THIS PRODUCT LINE FROM ALL BIDS
#REF!	Baseball & Softball	114	10	Top Lock Privacy Decorative Slats for Chainlink Fencing - 2-1/4" Mesh, 78 slats or 1 3/4" Mesh, *4'L, 9 lbs., TL9CL2 Standard colors: white, green, brown, black, beige, gray, redwood, royal blue, or light blue (600-1199 Bags)	Pexco	TL9CL2	BAG	\$ 47.500	5.0%				#REF! CALL FOR PRICE - EFFECTIVE 6/1/2021 DUE TO SUPPLY CHAIN ISSUES WE NEED TO EXCLUDE THIS PRODUCT LINE FROM ALL BIDS
#REF!	Baseball & Softball	114	10	Top Lock Privacy Decorative Slats for Chainlink Fencing - 2-1/4" Mesh, 78 slats or 1 3/4" Mesh, *5'L, 12 lbs., TL12CL2 Standard colors: white, green, brown, black, beige, gray, redwood, royal blue, or light blue (600-1199 Bags)	Pexco	TL12CL2	BAG	\$ 58.750	5.0%				#REF! CALL FOR PRICE - EFFECTIVE 6/1/2021 DUE TO SUPPLY CHAIN ISSUES WE NEED TO EXCLUDE THIS PRODUCT LINE FROM ALL BIDS
#REF!	Baseball & Softball	114	10	Top Lock Privacy Decorative Slats for Chainlink Fencing - 2-1/4" Mesh, 78 slats or 1 3/4" Mesh, *6'L, 14 lbs., TL14CL2 Standard colors: white, green, brown, black, beige, gray, redwood, royal blue, or light blue (600-1199 Bags)	Pexco	TL14CL2	BAG	\$ 71.250	5.0%				#REF! CALL FOR PRICE - EFFECTIVE 6/1/2021 DUE TO SUPPLY CHAIN ISSUES WE NEED TO EXCLUDE THIS PRODUCT LINE FROM ALL BIDS
#REF!	Baseball & Softball	114	10	Top Lock Privacy Decorative Slats for Chainlink Fencing - 2-1/4" Mesh, 78 slats or 1 3/4" Mesh, *7'L, 17 lbs., TL17CL2 Standard colors: white, green, brown, black, beige, gray, redwood, royal blue, or light blue (600-1199 Bags)	Pexco	TL17CL2	BAG	\$ 82.500	5.0%				#REF! CALL FOR PRICE - EFFECTIVE 6/1/2021 DUE TO SUPPLY CHAIN ISSUES WE NEED TO EXCLUDE THIS PRODUCT LINE FROM ALL BIDS
#REF!	Baseball & Softball	114	10	Top Lock Privacy Decorative Slats for Chainlink Fencing - 2-1/4" Mesh, 78 slats or 1 3/4" Mesh, *8'L, 19 lbs., TL19CL2 Standard colors: white, green, brown, black, beige, gray, redwood, royal blue, or light blue (600-1199 Bags)	Pexco	TL19CL2	BAG	\$ 95.000	5.0%				#REF! CALL FOR PRICE - EFFECTIVE 6/1/2021 DUE TO SUPPLY CHAIN ISSUES WE NEED TO EXCLUDE THIS PRODUCT LINE FROM ALL BIDS
#REF!	Baseball & Softball	114	10	Top Lock Privacy Decorative Slats for Chainlink Fencing - 2-1/4" Mesh, 78 slats or 1 3/4" Mesh, *10'L, 24 lbs., TL24CL2 Standard colors: white, green, brown, black, beige, gray, redwood, royal blue, or light blue (600-1199 Bags)	Pexco	TL24CL2	BAG	\$ 118.750	5.0%				#REF! CALL FOR PRICE - EFFECTIVE 6/1/2021 DUE TO SUPPLY CHAIN ISSUES WE NEED TO EXCLUDE THIS PRODUCT LINE FROM ALL BIDS
#REF!	Baseball & Softball	114	10	Top Lock Privacy Decorative Slats for Chainlink Fencing - 2-1/4" Mesh, 78 slats or 1 3/4" Mesh, *12'L, 29 lbs., TL29CL2 Standard colors: white, green, brown, black, beige, gray, redwood, royal blue, or light blue (600-1199 Bags)	Pexco	TL29CL2	BAG	\$ 142.500	5.0%				#REF! CALL FOR PRICE - EFFECTIVE 6/1/2021 DUE TO SUPPLY CHAIN ISSUES WE NEED TO EXCLUDE THIS PRODUCT LINE FROM ALL BIDS
#REF!	Baseball & Softball	114	10	Extra Channel - EC	Pexco	EC	LF	\$ 0.320	5.0%				#REF! CALL FOR PRICE - EFFECTIVE 6/1/2021 DUE TO SUPPLY CHAIN ISSUES WE NEED TO EXCLUDE THIS PRODUCT LINE FROM ALL BIDS
#REF!	Baseball & Softball	114	10	200' Channel Reel - CR	Pexco	CR	EACH	\$ 68.000	5.0%				#REF! CALL FOR PRICE - EFFECTIVE 6/1/2021 DUE TO SUPPLY CHAIN ISSUES WE NEED TO EXCLUDE THIS PRODUCT LINE FROM ALL BIDS
#REF!	Baseball & Softball	114	10	Winged Slat® Privacy Decorative Slats for Chainlink Fencing - 2", *3'L, 8 lbs., #WS8L1 Standard colors: white, green, brown, black, beige, gray, redwood, royal blue, or light blue (1-599 Bags)	Pexco	WS8L1	BAG	\$ 50.000	5.0%				#REF! CALL FOR PRICE - EFFECTIVE 6/1/2021 DUE TO SUPPLY CHAIN ISSUES WE NEED TO EXCLUDE THIS PRODUCT LINE FROM ALL BIDS
#REF!	Baseball & Softball	114	10	Winged Slat® Privacy Decorative Slats for Chainlink Fencing - 2", *3.5'L, 9 lbs., #WS9L1 Standard colors: white, green, brown, black, beige, gray, redwood, royal blue, or light blue (1-599 Bags)	Pexco	WS9L1	BAG	\$ 57.000	5.0%				#REF! CALL FOR PRICE - EFFECTIVE 6/1/2021 DUE TO SUPPLY CHAIN ISSUES WE NEED TO EXCLUDE THIS PRODUCT LINE FROM ALL BIDS
#REF!	Baseball & Softball	114	10	Winged Slat® Privacy Decorative Slats for Chainlink Fencing - 2", *4'L, 11 lbs., #WS11L1 Standard colors: white, green, brown, black, beige, gray, redwood, royal blue, or light blue (1-599 Bags)	Pexco	WS11L1	BAG	\$ 57.000	5.0%				#REF! CALL FOR PRICE - EFFECTIVE 6/1/2021 DUE TO SUPPLY CHAIN ISSUES WE NEED TO EXCLUDE THIS PRODUCT LINE FROM ALL BIDS
#REF!	Baseball & Softball	114	10	Winged Slat® Privacy Decorative Slats for Chainlink Fencing - 2", *5'L, 13 lbs., #WS13L1 Standard colors: white, green, brown, black, beige, gray, redwood, royal blue, or light blue (1-599 Bags)	Pexco	WS13L1	BAG	\$ 72.000	5.0%				#REF! CALL FOR PRICE - EFFECTIVE 6/1/2021 DUE TO SUPPLY CHAIN ISSUES WE NEED TO EXCLUDE THIS PRODUCT LINE FROM ALL BIDS
#REF!	Baseball & Softball	114	10	Winged Slat® Privacy Decorative Slats for Chainlink Fencing - 2", *6'L, 16 lbs., #WS16L1 Standard colors: white, green, brown, black, beige, gray, redwood, royal blue, or light blue (1-599 Bags)	Pexco	WS16L1	BAG	\$ 86.000	5.0%				#REF! CALL FOR PRICE - EFFECTIVE 6/1/2021 DUE TO SUPPLY CHAIN ISSUES WE NEED TO EXCLUDE THIS PRODUCT LINE FROM ALL BIDS
#REF!	Baseball & Softball	114	10	Winged Slat® Privacy Decorative Slats for Chainlink Fencing - 2", *7'L, 18 lbs., #WS18L1 Standard colors: white, green, brown, black, beige, gray, redwood, royal blue, or light blue (1-599 Bags)	Pexco	WS18L1	BAG	\$ 100.000	5.0%				#REF! CALL FOR PRICE - EFFECTIVE 6/1/2021 DUE TO SUPPLY CHAIN ISSUES WE NEED TO EXCLUDE THIS PRODUCT LINE FROM ALL BIDS
#REF!	Baseball & Softball	114	10	Winged Slat® Privacy Decorative Slats for Chainlink Fencing - 2", *8'L, 21 lbs., #WS21L1 Standard colors: white, green, brown, black, beige, gray, redwood, royal blue, or light blue (1-599 Bags)	Pexco	WS21L1	BAG	\$ 114.000	5.0%				#REF! CALL FOR PRICE - EFFECTIVE 6/1/2021 DUE TO SUPPLY CHAIN ISSUES WE NEED TO EXCLUDE THIS PRODUCT LINE FROM ALL BIDS
#REF!	Baseball & Softball	114	10	Winged Slat® Privacy Decorative Slats for Chainlink Fencing - 2", *3'L, 8 lbs., #WS8AL2 Standard colors: white, green, brown, black, beige, gray, redwood, royal blue, or light blue (600-1199 Bags)	Pexco	WS8AL2	BAG	\$ 44.000	5.0%				#REF! CALL FOR PRICE - EFFECTIVE 6/1/2021 DUE TO SUPPLY CHAIN ISSUES WE NEED TO EXCLUDE THIS PRODUCT LINE FROM ALL BIDS
#REF!	Baseball & Softball	114	10	Winged Slat® Privacy Decorative Slats for Chainlink Fencing - 2", *3.5'L, 9 lbs., #WS9L2 Standard colors: white, green, brown, black, beige, gray, redwood, royal blue, or light blue (600-1199 Bags)	Pexco	WS9L2	BAG	\$ 50.000	5.0%				#REF! CALL FOR PRICE - EFFECTIVE 6/1/2021 DUE TO SUPPLY CHAIN ISSUES WE NEED TO EXCLUDE THIS PRODUCT LINE FROM ALL BIDS
#REF!	Baseball & Softball	114	10	Winged Slat® Privacy Decorative Slats for Chainlink Fencing - 2", *4'L, 11 lbs., #WS11L2 Standard colors: white, green, brown, black, beige, gray, redwood, royal blue, or light blue (600-1199 Bags)	Pexco	WS11L2	BAG	\$ 50.000	5.0%				#REF! CALL FOR PRICE - EFFECTIVE 6/1/2021 DUE TO SUPPLY CHAIN ISSUES WE NEED TO EXCLUDE THIS PRODUCT LINE FROM ALL BIDS

Bidding Company Name:				Partac Peat Corporation		Catalog Name:		114 - Fence Guards, Rail Padding & Fence Slats				No.	
No.	Product Category	Beam Clay Catalog Section #	Page#	Product Description	Manufacturer	Vendor SKU	Unit of Measure	Catalog List Price	Bid Discount Percentage	Discount Amt.	Net Effective Bid Price	Comments	No.
#REF!	Baseball & Softball	114	10	Winged Slat® Privacy Decorative Slats for Chainlink Fencing - 2", *5'L, 13 lbs., #WS13L2 Standard colors: white, green, brown, black, beige, gray, redwood, royal blue, or light blue (600-1199 Bags)	Pexco	WS13L2	BAG	\$ 62.000	5.0%				#REF! CALL FOR PRICE - EFFECTIVE 6/1/2021 DUE TO SUPPLY CHAIN ISSUES WE NEED TO EXCLUDE THIS PRODUCT LINE FROM ALL BIDS
#REF!	Baseball & Softball	114	10	Winged Slat® Privacy Decorative Slats for Chainlink Fencing - 2", *6'L, 16 lbs., #WS16L2 Standard colors: white, green, brown, black, beige, gray, redwood, royal blue, or light blue (600-1199 Bags)	Pexco	WS16L2	BAG	\$ 75.000	5.0%				#REF! CALL FOR PRICE - EFFECTIVE 6/1/2021 DUE TO SUPPLY CHAIN ISSUES WE NEED TO EXCLUDE THIS PRODUCT LINE FROM ALL BIDS
#REF!	Baseball & Softball	114	10	Winged Slat® Privacy Decorative Slats for Chainlink Fencing - 2", *7'L, 18 lbs., #WS18L2 Standard colors: white, green, brown, black, beige, gray, redwood, royal blue, or light blue (600-1199 Bags)	Pexco	WS18L2	BAG	\$ 87.000	5.0%				#REF! CALL FOR PRICE - EFFECTIVE 6/1/2021 DUE TO SUPPLY CHAIN ISSUES WE NEED TO EXCLUDE THIS PRODUCT LINE FROM ALL BIDS
#REF!	Baseball & Softball	114	10	Winged Slat® Privacy Decorative Slats for Chainlink Fencing - 2", *8'L, 21 lbs., #WS21L2 Standard colors: white, green, brown, black, beige, gray, redwood, royal blue, or light blue (600-1199 Bags)	Pexco	WS21L2	BAG	\$ 100.000	5.0%				#REF! CALL FOR PRICE - EFFECTIVE 6/1/2021 DUE TO SUPPLY CHAIN ISSUES WE NEED TO EXCLUDE THIS PRODUCT LINE FROM ALL BIDS
#REF!	Baseball & Softball	114	10	Fin Link® Privacy Decorative Slats for Chainlink Fencing - 2", *3'L, 8 lbs., #FL8L1 Standard colors: white, green, brown, black, beige, gray, redwood, royal blue, or light blue (1-599 Bags)	Pexco	FL8L1	BAG	\$ 53.000	5.0%				#REF! CALL FOR PRICE - EFFECTIVE 6/1/2021 DUE TO SUPPLY CHAIN ISSUES WE NEED TO EXCLUDE THIS PRODUCT LINE FROM ALL BIDS
#REF!	Baseball & Softball	114	10	Fin Link® Privacy Decorative Slats for Chainlink Fencing - 2", *3.5'L, 9 lbs., #FL9L1 Standard colors: white, green, brown, black, beige, gray, redwood, royal blue, or light blue (1-599 Bags)	Pexco	FL9L1	BAG	\$ 60.000	5.0%				#REF! CALL FOR PRICE - EFFECTIVE 6/1/2021 DUE TO SUPPLY CHAIN ISSUES WE NEED TO EXCLUDE THIS PRODUCT LINE FROM ALL BIDS
#REF!	Baseball & Softball	114	10	Fin Link® Privacy Decorative Slats for Chainlink Fencing - 2", *4'L, 10 lbs., #FL10L1 Standard colors: white, green, brown, black, beige, gray, redwood, royal blue, or light blue (1-599 Bags)	Pexco	FL10L1	BAG	\$ 60.000	5.0%				#REF! CALL FOR PRICE - EFFECTIVE 6/1/2021 DUE TO SUPPLY CHAIN ISSUES WE NEED TO EXCLUDE THIS PRODUCT LINE FROM ALL BIDS
#REF!	Baseball & Softball	114	10	Fin Link® Privacy Decorative Slats for Chainlink Fencing - 2", *5'L, 12 lbs., #FL12L1 Standard colors: white, green, brown, black, beige, gray, redwood, royal blue, or light blue (1-599 Bags)	Pexco	FL12L1	BAG	\$ 75.000	5.0%				#REF! CALL FOR PRICE - EFFECTIVE 6/1/2021 DUE TO SUPPLY CHAIN ISSUES WE NEED TO EXCLUDE THIS PRODUCT LINE FROM ALL BIDS
#REF!	Baseball & Softball	114	10	Fin Link® Privacy Decorative Slats for Chainlink Fencing - 2", *6'L, 14 lbs., #FL14L1 Standard colors: white, green, brown, black, beige, gray, redwood, royal blue, or light blue (1-599 Bags)	Pexco	FL14L1	BAG	\$ 90.000	5.0%				#REF! CALL FOR PRICE - EFFECTIVE 6/1/2021 DUE TO SUPPLY CHAIN ISSUES WE NEED TO EXCLUDE THIS PRODUCT LINE FROM ALL BIDS
#REF!	Baseball & Softball	114	10	Fin Link® Privacy Decorative Slats for Chainlink Fencing - 2", *7'L, 16 lbs., #FL16L1 Standard colors: white, green, brown, black, beige, gray, redwood, royal blue, or light blue (1-599 Bags)	Pexco	FL16L1	BAG	\$ 105.000	5.0%				#REF! CALL FOR PRICE - EFFECTIVE 6/1/2021 DUE TO SUPPLY CHAIN ISSUES WE NEED TO EXCLUDE THIS PRODUCT LINE FROM ALL BIDS
#REF!	Baseball & Softball	114	10	Fin Link® Privacy Decorative Slats for Chainlink Fencing - 2", *8'L, 19 lbs., #FL19L1 Standard colors: white, green, brown, black, beige, gray, redwood, royal blue, or light blue (1-599 Bags)	Pexco	FL19L1	BAG	\$ 120.000	5.0%				#REF! CALL FOR PRICE - EFFECTIVE 6/1/2021 DUE TO SUPPLY CHAIN ISSUES WE NEED TO EXCLUDE THIS PRODUCT LINE FROM ALL BIDS
#REF!	Baseball & Softball	114	10	Fin Link® Privacy Decorative Slats for Chainlink Fencing - 2", *3'L, 8 lbs., #FL8L2 Standard colors: white, green, brown, black, beige, gray, redwood, royal blue, or light blue (600-1199 Bags)	Pexco	FL8L2	BAG	\$ 46.000	5.0%				#REF! CALL FOR PRICE - EFFECTIVE 6/1/2021 DUE TO SUPPLY CHAIN ISSUES WE NEED TO EXCLUDE THIS PRODUCT LINE FROM ALL BIDS
#REF!	Baseball & Softball	114	10	Fin Link® Privacy Decorative Slats for Chainlink Fencing - 2", *3.5'L, 9 lbs., #FL9L2 Standard colors: white, green, brown, black, beige, gray, redwood, royal blue, or light blue (600-1199 Bags)	Pexco	FL9L2	BAG	\$ 52.000	5.0%				#REF! CALL FOR PRICE - EFFECTIVE 6/1/2021 DUE TO SUPPLY CHAIN ISSUES WE NEED TO EXCLUDE THIS PRODUCT LINE FROM ALL BIDS
#REF!	Baseball & Softball	114	10	Fin Link® Privacy Decorative Slats for Chainlink Fencing - 2", *4'L, 10 lbs., #FL10L2 Standard colors: white, green, brown, black, beige, gray, redwood, royal blue, or light blue (600-1199 Bags)	Pexco	FL10L2	BAG	\$ 52.000	5.0%				#REF! CALL FOR PRICE - EFFECTIVE 6/1/2021 DUE TO SUPPLY CHAIN ISSUES WE NEED TO EXCLUDE THIS PRODUCT LINE FROM ALL BIDS
#REF!	Baseball & Softball	114	10	Fin Link® Privacy Decorative Slats for Chainlink Fencing - 2", *5'L, 12 lbs., #FL12L2 Standard colors: white, green, brown, black, beige, gray, redwood, royal blue, or light blue (600-1199 Bags)	Pexco	FL12L2	BAG	\$ 65.000	5.0%				#REF! CALL FOR PRICE - EFFECTIVE 6/1/2021 DUE TO SUPPLY CHAIN ISSUES WE NEED TO EXCLUDE THIS PRODUCT LINE FROM ALL BIDS
#REF!	Baseball & Softball	114	10	Fin Link® Privacy Decorative Slats for Chainlink Fencing - 2", *6'L, 14 lbs., #FL14L2 Standard colors: white, green, brown, black, beige, gray, redwood, royal blue, or light blue (600-1199 Bags)	Pexco	FL14L2	BAG	\$ 78.000	5.0%				#REF! CALL FOR PRICE - EFFECTIVE 6/1/2021 DUE TO SUPPLY CHAIN ISSUES WE NEED TO EXCLUDE THIS PRODUCT LINE FROM ALL BIDS
#REF!	Baseball & Softball	114	10	Fin Link® Privacy Decorative Slats for Chainlink Fencing - 2", *7'L, 16 lbs., #FL16L2 Standard colors: white, green, brown, black, beige, gray, redwood, royal blue, or light blue (600-1199 Bags)	Pexco	FL16L2	BAG	\$ 91.000	5.0%				#REF! CALL FOR PRICE - EFFECTIVE 6/1/2021 DUE TO SUPPLY CHAIN ISSUES WE NEED TO EXCLUDE THIS PRODUCT LINE FROM ALL BIDS
#REF!	Baseball & Softball	114	10	Fin Link® Privacy Decorative Slats for Chainlink Fencing - 2", *8'L, 19 lbs., #FL19L2 Standard colors: white, green, brown, black, beige, gray, redwood, royal blue, or light blue (600-1199 Bags)	Pexco	FL19L2	BAG	\$ 104.000	5.0%				#REF! CALL FOR PRICE - EFFECTIVE 6/1/2021 DUE TO SUPPLY CHAIN ISSUES WE NEED TO EXCLUDE THIS PRODUCT LINE FROM ALL BIDS
#REF!	Baseball & Softball	114	10	Extra Channel - EC	Pexco	EC	LF	\$ 0.320	5.0%				#REF! CALL FOR PRICE - EFFECTIVE 6/1/2021 DUE TO SUPPLY CHAIN ISSUES WE NEED TO EXCLUDE THIS PRODUCT LINE FROM ALL BIDS
#REF!	Baseball & Softball	114	10	LiteLink® Privacy Decorative Slats for Chainlink Fencing - Fits 2" and 2 1/4" mesh, *3'L, 4 lbs., #LL4L1 Standard colors: white, green, brown, black, beige, gray, redwood, royal blue, or light blue (1-599 Bags)	Pexco	LL4L1	BAG	\$ 31.000	5.0%				#REF! CALL FOR PRICE - EFFECTIVE 6/1/2021 DUE TO SUPPLY CHAIN ISSUES WE NEED TO EXCLUDE THIS PRODUCT LINE FROM ALL BIDS
#REF!	Baseball & Softball	114	10	LiteLink® Privacy Decorative Slats for Chainlink Fencing - Fits 2" and 2 1/4" mesh, *3.5'L, 5 lbs., #LL5L1 Standard colors: white, green, brown, black, beige, gray, redwood, royal blue, or light blue (1-599 Bags)	Pexco	LL5L1	BAG	\$ 35.000	5.0%				#REF! CALL FOR PRICE - EFFECTIVE 6/1/2021 DUE TO SUPPLY CHAIN ISSUES WE NEED TO EXCLUDE THIS PRODUCT LINE FROM ALL BIDS
#REF!	Baseball & Softball	114	10	LiteLink® Privacy Decorative Slats for Chainlink Fencing - Fits 2" and 2 1/4" mesh, *4'L, 6 lbs., #LL6L1 Standard colors: white, green, brown, black, beige, gray, redwood, royal blue, or light blue (1-599 Bags)	Pexco	LL6L1	BAG	\$ 35.000	5.0%				#REF! CALL FOR PRICE - EFFECTIVE 6/1/2021 DUE TO SUPPLY CHAIN ISSUES WE NEED TO EXCLUDE THIS PRODUCT LINE FROM ALL BIDS
#REF!	Baseball & Softball	114	10	LiteLink® Privacy Decorative Slats for Chainlink Fencing - Fits 2" and 2 1/4" mesh, *5'L, 7 lbs., #LL7L1 Standard colors: white, green, brown, black, beige, gray, redwood, royal blue, or light blue (1-599 Bags)	Pexco	LL7L1	BAG	\$ 44.000	5.0%				#REF! CALL FOR PRICE - EFFECTIVE 6/1/2021 DUE TO SUPPLY CHAIN ISSUES WE NEED TO EXCLUDE THIS PRODUCT LINE FROM ALL BIDS

Bidding Company Name:				Partac Peat Corporation		Catalog Name:		114 - Fence Guards, Rail Padding & Fence Slats					No.
No.	Product Category	Beam Clay Catalog Section #	Page#	Product Description	Manufacturer	Vendor SKU	Unit of Measure	Catalog List Price	Bid Discount Percentage	Discount Amt.	Net Effective Bid Price	Comments	No.
#REF!	Baseball & Softball	114	10	LiteLink® Privacy Decorative Slats for Chainlink Fencing - Fits 2" and 2 1/4" mesh, *6'L, 9 lbs., #LL9L1 Standard colors: white, green, brown, black, beige, gray, redwood, royal blue, or light blue (1-599 Bags)	Pexco	LL9L1	BAG	\$ 53.000	5.0%				#REF! CALL FOR PRICE - EFFECTIVE 6/1/2021 DUE TO SUPPLY CHAIN ISSUES WE NEED TO EXCLUDE THIS PRODUCT LINE FROM ALL BIDS
#REF!	Baseball & Softball	114	10	LiteLink® Privacy Decorative Slats for Chainlink Fencing - Fits 2" and 2 1/4" mesh, *7'L, 10 lbs., #LL10L1 Standard colors: white, green, brown, black, beige, gray, redwood, royal blue, or light blue (1-599 Bags)	Pexco	LL10L1	BAG	\$ 61.000	5.0%				#REF! CALL FOR PRICE - EFFECTIVE 6/1/2021 DUE TO SUPPLY CHAIN ISSUES WE NEED TO EXCLUDE THIS PRODUCT LINE FROM ALL BIDS
#REF!	Baseball & Softball	114	10	LiteLink® Privacy Decorative Slats for Chainlink Fencing - Fits 2" and 2 1/4" mesh, *8'L, 11 lbs., #LL11L1 Standard colors: white, green, brown, black, beige, gray, redwood, royal blue, or light blue (1-599 Bags)	Pexco	LL11L1	BAG	\$ 70.000	5.0%				#REF! CALL FOR PRICE - EFFECTIVE 6/1/2021 DUE TO SUPPLY CHAIN ISSUES WE NEED TO EXCLUDE THIS PRODUCT LINE FROM ALL BIDS
#REF!	Baseball & Softball	114	10	LiteLink® Privacy Decorative Slats for Chainlink Fencing - Fits 2" and 2 1/4" mesh, *10'L, 14 lbs., #LL14L1 Standard colors: white, green, brown, black, beige, gray, redwood, royal blue, or light blue (1-599 Bags)	Pexco	LL14L1	BAG	\$ 87.000	5.0%				#REF! CALL FOR PRICE - EFFECTIVE 6/1/2021 DUE TO SUPPLY CHAIN ISSUES WE NEED TO EXCLUDE THIS PRODUCT LINE FROM ALL BIDS
#REF!	Baseball & Softball	114	10	LiteLink® Privacy Decorative Slats for Chainlink Fencing - Fits 2" and 2 1/4" mesh, *12"L, 17 lbs., #LL17L1 Standard colors: white, green, brown, black, beige, gray, redwood, royal blue, or light blue (1-599 Bags)	Pexco	LL17L1	BAG	\$ 105.000	5.0%				#REF! CALL FOR PRICE - EFFECTIVE 6/1/2021 DUE TO SUPPLY CHAIN ISSUES WE NEED TO EXCLUDE THIS PRODUCT LINE FROM ALL BIDS
#REF!	Baseball & Softball	114	10	LiteLink® Privacy Decorative Slats for Chainlink Fencing - Fits 2" and 2 1/4" mesh, *3'L, 4 lbs., #LL4L2 Standard colors: white, green, brown, black, beige, gray, redwood, royal blue, or light blue (600-1199 Bags)	Pexco	LL4L2	BAG	\$ 27.000	5.0%				#REF! CALL FOR PRICE - EFFECTIVE 6/1/2021 DUE TO SUPPLY CHAIN ISSUES WE NEED TO EXCLUDE THIS PRODUCT LINE FROM ALL BIDS
#REF!	Baseball & Softball	114	10	LiteLink® Privacy Decorative Slats for Chainlink Fencing - Fits 2" and 2 1/4" mesh, *3.5'L, 5 lbs., #LL5L2 Standard colors: white, green, brown, black, beige, gray, redwood, royal blue, or light blue (600-1199 Bags)	Pexco	LL5L2	BAG	\$ 31.000	5.0%				#REF! CALL FOR PRICE - EFFECTIVE 6/1/2021 DUE TO SUPPLY CHAIN ISSUES WE NEED TO EXCLUDE THIS PRODUCT LINE FROM ALL BIDS
#REF!	Baseball & Softball	114	10	LiteLink® Privacy Decorative Slats for Chainlink Fencing - Fits 2" and 2 1/4" mesh, *4'L, 6 lbs., #LL6L2 Standard colors: white, green, brown, black, beige, gray, redwood, royal blue, or light blue (600-1199 Bags)	Pexco	LL6L2	BAG	\$ 31.000	5.0%				#REF! CALL FOR PRICE - EFFECTIVE 6/1/2021 DUE TO SUPPLY CHAIN ISSUES WE NEED TO EXCLUDE THIS PRODUCT LINE FROM ALL BIDS
#REF!	Baseball & Softball	114	10	LiteLink® Privacy Decorative Slats for Chainlink Fencing - Fits 2" and 2 1/4" mesh, *5'L, 7 lbs., #LL7L2 Standard colors: white, green, brown, black, beige, gray, redwood, royal blue, or light blue (600-1199 Bags)	Pexco	LL7L2	BAG	\$ 38.000	5.0%				#REF! CALL FOR PRICE - EFFECTIVE 6/1/2021 DUE TO SUPPLY CHAIN ISSUES WE NEED TO EXCLUDE THIS PRODUCT LINE FROM ALL BIDS
#REF!	Baseball & Softball	114	10	LiteLink® Privacy Decorative Slats for Chainlink Fencing - Fits 2" and 2 1/4" mesh, *6'L, 9 lbs., #LL9L2 Standard colors: white, green, brown, black, beige, gray, redwood, royal blue, or light blue (600-1199 Bags)	Pexco	LL9L2	BAG	\$ 46.000	5.0%				#REF! CALL FOR PRICE - EFFECTIVE 6/1/2021 DUE TO SUPPLY CHAIN ISSUES WE NEED TO EXCLUDE THIS PRODUCT LINE FROM ALL BIDS
#REF!	Baseball & Softball	114	10	LiteLink® Privacy Decorative Slats for Chainlink Fencing - Fits 2" and 2 1/4" mesh, *7'L, 10 lbs., #LL10L2 Standard colors: white, green, brown, black, beige, gray, redwood, royal blue, or light blue (600-1199 Bags)	Pexco	LL10L2	BAG	\$ 53.000	5.0%				#REF! CALL FOR PRICE - EFFECTIVE 6/1/2021 DUE TO SUPPLY CHAIN ISSUES WE NEED TO EXCLUDE THIS PRODUCT LINE FROM ALL BIDS
#REF!	Baseball & Softball	114	10	LiteLink® Privacy Decorative Slats for Chainlink Fencing - Fits 2" and 2 1/4" mesh, *8'L, 11 lbs., #LL11L2 Standard colors: white, green, brown, black, beige, gray, redwood, royal blue, or light blue (600-1199 Bags)	Pexco	LL11L2	BAG	\$ 51.000	5.0%				#REF! CALL FOR PRICE - EFFECTIVE 6/1/2021 DUE TO SUPPLY CHAIN ISSUES WE NEED TO EXCLUDE THIS PRODUCT LINE FROM ALL BIDS
#REF!	Baseball & Softball	114	10	LiteLink® Privacy Decorative Slats for Chainlink Fencing - Fits 2" and 2 1/4" mesh, *10'L, 14 lbs., #LL14L2 Standard colors: white, green, brown, black, beige, gray, redwood, royal blue, or light blue (600-1199 Bags)	Pexco	LL14L2	BAG	\$ 76.000	5.0%				#REF! CALL FOR PRICE - EFFECTIVE 6/1/2021 DUE TO SUPPLY CHAIN ISSUES WE NEED TO EXCLUDE THIS PRODUCT LINE FROM ALL BIDS
#REF!	Baseball & Softball	114	10	LiteLink® Privacy Decorative Slats for Chainlink Fencing - Fits 2" and 2 1/4" mesh, *12"L, 17 lbs., #LL17L2 Standard colors: white, green, brown, black, beige, gray, redwood, royal blue, or light blue (600-1199 Bags)	Pexco	LL17L2	BAG	\$ 91.000	5.0%				#REF! CALL FOR PRICE - EFFECTIVE 6/1/2021 DUE TO SUPPLY CHAIN ISSUES WE NEED TO EXCLUDE THIS PRODUCT LINE FROM ALL BIDS
#REF!	Baseball & Softball	114	10	HedgeLink® Privacy Decorative Slats for Chainlink Fencing - Fits 2" and 2 1/4" mesh, *4'L, 17 lbs., #HL17L1 Standard colors: white, green, brown, black, beige, gray, redwood, royal blue, or light blue (1-599 Bags)	Pexco	HL17L1	BAG	\$ 112.000	5.0%				#REF! CALL FOR PRICE - EFFECTIVE 6/1/2021 DUE TO SUPPLY CHAIN ISSUES WE NEED TO EXCLUDE THIS PRODUCT LINE FROM ALL BIDS
#REF!	Baseball & Softball	114	10	HedgeLink® Privacy Decorative Slats for Chainlink Fencing - Fits 2" and 2 1/4" mesh, *5'L, 20 lbs., #HL20L1 Standard colors: white, green, brown, black, beige, gray, redwood, royal blue, or light blue (1-599 Bags)	Pexco	HL20L1	BAG	\$ 131.000	5.0%				#REF! CALL FOR PRICE - EFFECTIVE 6/1/2021 DUE TO SUPPLY CHAIN ISSUES WE NEED TO EXCLUDE THIS PRODUCT LINE FROM ALL BIDS
#REF!	Baseball & Softball	114	10	HedgeLink® Privacy Decorative Slats for Chainlink Fencing - Fits 2" and 2 1/4" mesh, *6'L, 25 lbs., #HL25L1 Standard colors: white, green, brown, black, beige, gray, redwood, royal blue, or light blue (1-599 Bags)	Pexco	HL25L1	BAG	\$ 160.000	5.0%				#REF! CALL FOR PRICE - EFFECTIVE 6/1/2021 DUE TO SUPPLY CHAIN ISSUES WE NEED TO EXCLUDE THIS PRODUCT LINE FROM ALL BIDS
#REF!	Baseball & Softball	114	10	HedgeLink® Privacy Decorative Slats for Chainlink Fencing - Fits 2" and 2 1/4" mesh, *7'L, 29 lbs., #HL29L1 Standard colors: white, green, brown, black, beige, gray, redwood, royal blue, or light blue (1-599 Bags)	Pexco	HL29L1	BAG	\$ 182.000	5.0%				#REF! CALL FOR PRICE - EFFECTIVE 6/1/2021 DUE TO SUPPLY CHAIN ISSUES WE NEED TO EXCLUDE THIS PRODUCT LINE FROM ALL BIDS
#REF!	Baseball & Softball	114	10	HedgeLink® Privacy Decorative Slats for Chainlink Fencing - Fits 2" and 2 1/4" mesh, *8'L, 33 lbs., #HL33L1 Standard colors: white, green, brown, black, beige, gray, redwood, royal blue, or light blue (1-599 Bags)	Pexco	HL33L1	BAG	\$ 204.000	5.0%				#REF! CALL FOR PRICE - EFFECTIVE 6/1/2021 DUE TO SUPPLY CHAIN ISSUES WE NEED TO EXCLUDE THIS PRODUCT LINE FROM ALL BIDS
#REF!	Baseball & Softball	114	10	HedgeLink® Privacy Decorative Slats for Chainlink Fencing - Fits 2" and 2 1/4" mesh, *10'L, 40 lbs., #HL40L1 Standard colors: white, green, brown, black, beige, gray, redwood, royal blue, or light blue (1-599 Bags)	Pexco	HL40L1	BAG	\$ 271.000	5.0%				#REF! CALL FOR PRICE - EFFECTIVE 6/1/2021 DUE TO SUPPLY CHAIN ISSUES WE NEED TO EXCLUDE THIS PRODUCT LINE FROM ALL BIDS
#REF!	Baseball & Softball	114	10	HedgeLink® Privacy Decorative Slats for Chainlink Fencing - Fits 2" and 2 1/4" mesh, *4'L, 17 lbs., #HL17L2 Standard colors: white, green, brown, black, beige, gray, redwood, royal blue, or light blue (600-1199 Bags)	Pexco	HL17L2	BAG	\$ 103.000	5.0%				#REF! CALL FOR PRICE - EFFECTIVE 6/1/2021 DUE TO SUPPLY CHAIN ISSUES WE NEED TO EXCLUDE THIS PRODUCT LINE FROM ALL BIDS
#REF!	Baseball & Softball	114	10	HedgeLink® Privacy Decorative Slats for Chainlink Fencing - Fits 2" and 2 1/4" mesh, *5'L, 20 lbs., #HL20L2 Standard colors: white, green, brown, black, beige, gray, redwood, royal blue, or light blue (600-1199 Bags)	Pexco	HL20L2	BAG	\$ 120.000	5.0%				#REF! CALL FOR PRICE - EFFECTIVE 6/1/2021 DUE TO SUPPLY CHAIN ISSUES WE NEED TO EXCLUDE THIS PRODUCT LINE FROM ALL BIDS
#REF!	Baseball & Softball	114	10	HedgeLink® Privacy Decorative Slats for Chainlink Fencing - Fits 2" and 2 1/4" mesh, *6'L, 25 lbs., #HL25L2 Standard colors: white, green, brown, black, beige, gray, redwood, royal blue, or light blue (600-1199 Bags)	Pexco	HL25L2	BAG	\$ 146.000	5.0%				#REF! CALL FOR PRICE - EFFECTIVE 6/1/2021 DUE TO SUPPLY CHAIN ISSUES WE NEED TO EXCLUDE THIS PRODUCT LINE FROM ALL BIDS

Bidding Company Name:				Partac Peat Corporation		Catalog Name:		114 - Fence Guards, Rail Padding & Fence Slats						
No.	Product Category	Beam Clay Catalog Section #	Page#	Product Description	Manufacturer	Vendor SKU	Unit of Measure	Catalog List Price	Bid Discount Percentage	Discount Amt.	Net Effective Bid Price	Comments	No.	
#REF!	Baseball & Softball	114	10	HedgeLink® Privacy Decorative Slats for Chainlink Fencing - Fits 2" and 2 1/4" mesh, *7'L, 29 lbs., #HL29L2 Standard colors: white, green, brown, black, beige, gray, redwood, royal blue, or light blue (600-1199 Bags)	Pexco	HL29L2	BAG	\$ 167.000	5.0%				#REF!	CALL FOR PRICE - EFFECTIVE 6/1/2021 DUE TO SUPPLY CHAIN ISSUES WE NEED TO EXCLUDE THIS PRODUCT LINE FROM ALL BIDS
#REF!	Baseball & Softball	114	10	HedgeLink® Privacy Decorative Slats for Chainlink Fencing - Fits 2" and 2 1/4" mesh, *8'L, 33 lbs., #HL33L2 Standard colors: white, green, brown, black, beige, gray, redwood, royal blue, or light blue (600-1199 Bags)	Pexco	HL33L2	BAG	\$ 187.000	5.0%				#REF!	CALL FOR PRICE - EFFECTIVE 6/1/2021 DUE TO SUPPLY CHAIN ISSUES WE NEED TO EXCLUDE THIS PRODUCT LINE FROM ALL BIDS
#REF!	Baseball & Softball	114	10	HedgeLink® Privacy Decorative Slats for Chainlink Fencing - Fits 2" and 2 1/4" mesh, *10'L, 40 lbs., #HL40L2 Standard colors: white, green, brown, black, beige, gray, redwood, royal blue, or light blue (600-1199 Bags)	Pexco	HL40L2	BAG	\$ 248.000	5.0%				#REF!	CALL FOR PRICE - EFFECTIVE 6/1/2021 DUE TO SUPPLY CHAIN ISSUES WE NEED TO EXCLUDE THIS PRODUCT LINE FROM ALL BIDS